



| 機械設備工事特記仕様書   |   | 給湯設備     | 配管材料  | ※ 一般配管用ステンレス鋼管<br>・ 鋼管 (硬質M)<br>・ 水道用耐熱性硬質塩化ビニルライニング鋼管<br>◎ 図示による   | その他   | 1 ステンレス材を酸洗いした場合、その廃液は産業廃棄物として適切に処理を行なうこと。<br>2 舗装版切断時の濁水は産業廃棄物として適切に処理を行うこと。 |   |     |     |     |     |     |     |      |      |     |     |    |    |     |     |        |        |     |     |       |       |      |      |        |        |        |        |       |       |      |      |     |     |      |      |     |     |      |      |             |             |           |           |             |             |     |     |      |      |         |         |       |       |       |       |              |              |      |      |    |    |          |          |     |     |           |           |         |         |      |      |     |     |       |       |     |     |              |              |                 |                 |
|---------------|---|----------|---|---|---|---|---|-----|-----|-----|-----|-----|-----|------|------|-----|-----|----|----|-----|-----|--------|--------|-----|-----|-------|-------|------|------|--------|--------|--------|--------|-------|-------|------|------|-----|-----|------|------|-----|-----|------|------|-------------|-------------|-----------|-----------|-------------|-------------|-----|-----|------|------|---------|---------|-------|-------|-------|-------|--------------|--------------|------|------|----|----|----------|----------|-----|-----|-----------|-----------|---------|---------|------|------|-----|-----|-------|-------|-----|-----|--------------|--------------|-----------------|-----------------|
| 11 機器類の落下防止措置 | 吊り機器類の振れ止めは、「防災拠点等における設備地震対策ガイドライン (静岡県)」による。<br>吊りボルトの規定長さが0.4m未満の場合は、設置状況に応じた適切な振れ止めを行うこと。  | 1 配管材料   | ※ 一般配管用ステンレス鋼管<br>・ 鋼管 (硬質M)<br>・ 水道用耐熱性硬質塩化ビニルライニング鋼管<br>◎ 図示による   | 屋内露出 ※ 合成樹脂製カバー<br>屋外露出 ・ 合成樹脂製カバー<br>※ ステンレス鋼板   | <p>別表 1</p> <table border="1"> <tr><th>名</th><th>称</th></tr> <tr><td>◎</td><td>配管類</td></tr> <tr><td>◎</td><td>給水管</td></tr> <tr><td>◎</td><td>排水管</td></tr> <tr><td>◎</td><td>冷温水管</td></tr> <tr><td>◎</td><td>冷煤管</td></tr> <tr><td>・</td><td>弁類</td></tr> <tr><td>◎</td><td>仕切弁</td></tr> <tr><td>・</td><td>バタフライ弁</td></tr> <tr><td>◎</td><td>逆止弁</td></tr> <tr><td>◎</td><td>緊急遮断弁</td></tr> <tr><td>・</td><td>ポンプ類</td></tr> <tr><td>◎</td><td>給水用ポンプ</td></tr> <tr><td>・</td><td>空調用ポンプ</td></tr> <tr><td>・</td><td>消火ポンプ</td></tr> <tr><td>・</td><td>タンク類</td></tr> <tr><td>◎</td><td>受水槽</td></tr> <tr><td>・</td><td>高架水槽</td></tr> <tr><td>・</td><td>貯湯槽</td></tr> <tr><td>・</td><td>膨張水槽</td></tr> <tr><td>・</td><td>空気調和設備工事用機材</td></tr> <tr><td>◎</td><td>パッケージエアコン</td></tr> <tr><td>・</td><td>空気調和機 (AHU)</td></tr> <tr><td>・</td><td>冷却塔</td></tr> <tr><td>・</td><td>ヘッダー</td></tr> <tr><td>・</td><td>自動制御機器類</td></tr> <tr><td>・</td><td>中央監視盤</td></tr> <tr><td>・</td><td>リモート盤</td></tr> <tr><td>・</td><td>給排水衛生設備工事用機材</td></tr> <tr><td>◎</td><td>衛生器具</td></tr> <tr><td>◎</td><td>水栓</td></tr> <tr><td>◎</td><td>組立てマンホール</td></tr> <tr><td>・</td><td>浄化槽</td></tr> <tr><td>・</td><td>F R P 浄化槽</td></tr> <tr><td>・</td><td>動力盤、制御盤</td></tr> <tr><td>・</td><td>プロワー</td></tr> <tr><td>・</td><td>さく井</td></tr> <tr><td>・</td><td>スクリーン</td></tr> <tr><td>・</td><td>その他</td></tr> <tr><td>◎</td><td>スリーブ (つば付鋼管)</td></tr> <tr><td>・</td><td>◎ 印の付いたものを適用する。</td></tr> </table> | 名   | 称 | ◎   | 配管類 | ◎   | 給水管 | ◎   | 排水管 | ◎    | 冷温水管 | ◎   | 冷煤管 | ・  | 弁類 | ◎   | 仕切弁 | ・      | バタフライ弁 | ◎   | 逆止弁 | ◎     | 緊急遮断弁 | ・    | ポンプ類 | ◎      | 給水用ポンプ | ・      | 空調用ポンプ | ・     | 消火ポンプ | ・    | タンク類 | ◎   | 受水槽 | ・    | 高架水槽 | ・   | 貯湯槽 | ・    | 膨張水槽 | ・           | 空気調和設備工事用機材 | ◎         | パッケージエアコン | ・           | 空気調和機 (AHU) | ・   | 冷却塔 | ・    | ヘッダー | ・       | 自動制御機器類 | ・     | 中央監視盤 | ・     | リモート盤 | ・            | 給排水衛生設備工事用機材 | ◎    | 衛生器具 | ◎  | 水栓 | ◎        | 組立てマンホール | ・   | 浄化槽 | ・         | F R P 浄化槽 | ・       | 動力盤、制御盤 | ・    | プロワー | ・   | さく井 | ・     | スクリーン | ・   | その他 | ◎            | スリーブ (つば付鋼管) | ・               | ◎ 印の付いたものを適用する。 |
| 名             | 称   |          |   |   |   |   |   |     |     |     |     |     |     |      |      |     |     |    |    |     |     |        |        |     |     |       |       |      |      |        |        |        |        |       |       |      |      |     |     |      |      |     |     |      |      |             |             |           |           |             |             |     |     |      |      |         |         |       |       |       |       |              |              |      |      |    |    |          |          |     |     |           |           |         |         |      |      |     |     |       |       |     |     |              |              |                 |                 |
| ◎             | 配管類   |          |   |   |   |   |   |     |     |     |     |     |     |      |      |     |     |    |    |     |     |        |        |     |     |       |       |      |      |        |        |        |        |       |       |      |      |     |     |      |      |     |     |      |      |             |             |           |           |             |             |     |     |      |      |         |         |       |       |       |       |              |              |      |      |    |    |          |          |     |     |           |           |         |         |      |      |     |     |       |       |     |     |              |              |                 |                 |
| ◎             | 給水管   |          |   |   |   |   |   |     |     |     |     |     |     |      |      |     |     |    |    |     |     |        |        |     |     |       |       |      |      |        |        |        |        |       |       |      |      |     |     |      |      |     |     |      |      |             |             |           |           |             |             |     |     |      |      |         |         |       |       |       |       |              |              |      |      |    |    |          |          |     |     |           |           |         |         |      |      |     |     |       |       |     |     |              |              |                 |                 |
| ◎             | 排水管   |          |   |   |   |   |   |     |     |     |     |     |     |      |      |     |     |    |    |     |     |        |        |     |     |       |       |      |      |        |        |        |        |       |       |      |      |     |     |      |      |     |     |      |      |             |             |           |           |             |             |     |     |      |      |         |         |       |       |       |       |              |              |      |      |    |    |          |          |     |     |           |           |         |         |      |      |     |     |       |       |     |     |              |              |                 |                 |
| ◎             | 冷温水管  |          |   |   |   |   |   |     |     |     |     |     |     |      |      |     |     |    |    |     |     |        |        |     |     |       |       |      |      |        |        |        |        |       |       |      |      |     |     |      |      |     |     |      |      |             |             |           |           |             |             |     |     |      |      |         |         |       |       |       |       |              |              |      |      |    |    |          |          |     |     |           |           |         |         |      |      |     |     |       |       |     |     |              |              |                 |                 |
| ◎             | 冷煤管   |          |   |   |   |   |   |     |     |     |     |     |     |      |      |     |     |    |    |     |     |        |        |     |     |       |       |      |      |        |        |        |        |       |       |      |      |     |     |      |      |     |     |      |      |             |             |           |           |             |             |     |     |      |      |         |         |       |       |       |       |              |              |      |      |    |    |          |          |     |     |           |           |         |         |      |      |     |     |       |       |     |     |              |              |                 |                 |
| ・             | 弁類  |          |   |   |   |   |   |     |     |     |     |     |     |      |      |     |     |    |    |     |     |        |        |     |     |       |       |      |      |        |        |        |        |       |       |      |      |     |     |      |      |     |     |      |      |             |             |           |           |             |             |     |     |      |      |         |         |       |       |       |       |              |              |      |      |    |    |          |          |     |     |           |           |         |         |      |      |     |     |       |       |     |     |              |              |                 |                 |
| ◎             | 仕切弁   |          |   |   |   |   |   |     |     |     |     |     |     |      |      |     |     |    |    |     |     |        |        |     |     |       |       |      |      |        |        |        |        |       |       |      |      |     |     |      |      |     |     |      |      |             |             |           |           |             |             |     |     |      |      |         |         |       |       |       |       |              |              |      |      |    |    |          |          |     |     |           |           |         |         |      |      |     |     |       |       |     |     |              |              |                 |                 |
| ・             | バタフライ弁  |          |   |   |   |   |   |     |     |     |     |     |     |      |      |     |     |    |    |     |     |        |        |     |     |       |       |      |      |        |        |        |        |       |       |      |      |     |     |      |      |     |     |      |      |             |             |           |           |             |             |     |     |      |      |         |         |       |       |       |       |              |              |      |      |    |    |          |          |     |     |           |           |         |         |      |      |     |     |       |       |     |     |              |              |                 |                 |
| ◎             | 逆止弁   |          |   |   |   |   |   |     |     |     |     |     |     |      |      |     |     |    |    |     |     |        |        |     |     |       |       |      |      |        |        |        |        |       |       |      |      |     |     |      |      |     |     |      |      |             |             |           |           |             |             |     |     |      |      |         |         |       |       |       |       |              |              |      |      |    |    |          |          |     |     |           |           |         |         |      |      |     |     |       |       |     |     |              |              |                 |                 |
| ◎             | 緊急遮断弁   |          |   |   |   |   |   |     |     |     |     |     |     |      |      |     |     |    |    |     |     |        |        |     |     |       |       |      |      |        |        |        |        |       |       |      |      |     |     |      |      |     |     |      |      |             |             |           |           |             |             |     |     |      |      |         |         |       |       |       |       |              |              |      |      |    |    |          |          |     |     |           |           |         |         |      |      |     |     |       |       |     |     |              |              |                 |                 |
| ・             | ポンプ類  |          |   |   |   |   |   |     |     |     |     |     |     |      |      |     |     |    |    |     |     |        |        |     |     |       |       |      |      |        |        |        |        |       |       |      |      |     |     |      |      |     |     |      |      |             |             |           |           |             |             |     |     |      |      |         |         |       |       |       |       |              |              |      |      |    |    |          |          |     |     |           |           |         |         |      |      |     |     |       |       |     |     |              |              |                 |                 |
| ◎             | 給水用ポンプ  |          |   |   |   |   |   |     |     |     |     |     |     |      |      |     |     |    |    |     |     |        |        |     |     |       |       |      |      |        |        |        |        |       |       |      |      |     |     |      |      |     |     |      |      |             |             |           |           |             |             |     |     |      |      |         |         |       |       |       |       |              |              |      |      |    |    |          |          |     |     |           |           |         |         |      |      |     |     |       |       |     |     |              |              |                 |                 |
| ・             | 空調用ポンプ  |          |   |   |   |   |   |     |     |     |     |     |     |      |      |     |     |    |    |     |     |        |        |     |     |       |       |      |      |        |        |        |        |       |       |      |      |     |     |      |      |     |     |      |      |             |             |           |           |             |             |     |     |      |      |         |         |       |       |       |       |              |              |      |      |    |    |          |          |     |     |           |           |         |         |      |      |     |     |       |       |     |     |              |              |                 |                 |
| ・             | 消火ポンプ   |          |   |   |   |   |   |     |     |     |     |     |     |      |      |     |     |    |    |     |     |        |        |     |     |       |       |      |      |        |        |        |        |       |       |      |      |     |     |      |      |     |     |      |      |             |             |           |           |             |             |     |     |      |      |         |         |       |       |       |       |              |              |      |      |    |    |          |          |     |     |           |           |         |         |      |      |     |     |       |       |     |     |              |              |                 |                 |
| ・             | タンク類  |          |   |   |   |   |   |     |     |     |     |     |     |      |      |     |     |    |    |     |     |        |        |     |     |       |       |      |      |        |        |        |        |       |       |      |      |     |     |      |      |     |     |      |      |             |             |           |           |             |             |     |     |      |      |         |         |       |       |       |       |              |              |      |      |    |    |          |          |     |     |           |           |         |         |      |      |     |     |       |       |     |     |              |              |                 |                 |
| ◎             | 受水槽   |          |   |   |   |   |   |     |     |     |     |     |     |      |      |     |     |    |    |     |     |        |        |     |     |       |       |      |      |        |        |        |        |       |       |      |      |     |     |      |      |     |     |      |      |             |             |           |           |             |             |     |     |      |      |         |         |       |       |       |       |              |              |      |      |    |    |          |          |     |     |           |           |         |         |      |      |     |     |       |       |     |     |              |              |                 |                 |
| ・             | 高架水槽  |          |   |   |   |   |   |     |     |     |     |     |     |      |      |     |     |    |    |     |     |        |        |     |     |       |       |      |      |        |        |        |        |       |       |      |      |     |     |      |      |     |     |      |      |             |             |           |           |             |             |     |     |      |      |         |         |       |       |       |       |              |              |      |      |    |    |          |          |     |     |           |           |         |         |      |      |     |     |       |       |     |     |              |              |                 |                 |
| ・             | 貯湯槽   |          |   |   |   |   |   |     |     |     |     |     |     |      |      |     |     |    |    |     |     |        |        |     |     |       |       |      |      |        |        |        |        |       |       |      |      |     |     |      |      |     |     |      |      |             |             |           |           |             |             |     |     |      |      |         |         |       |       |       |       |              |              |      |      |    |    |          |          |     |     |           |           |         |         |      |      |     |     |       |       |     |     |              |              |                 |                 |
| ・             | 膨張水槽  |          |   |   |   |   |   |     |     |     |     |     |     |      |      |     |     |    |    |     |     |        |        |     |     |       |       |      |      |        |        |        |        |       |       |      |      |     |     |      |      |     |     |      |      |             |             |           |           |             |             |     |     |      |      |         |         |       |       |       |       |              |              |      |      |    |    |          |          |     |     |           |           |         |         |      |      |     |     |       |       |     |     |              |              |                 |                 |
| ・             | 空気調和設備工事用機材   |          |   |   |   |   |   |     |     |     |     |     |     |      |      |     |     |    |    |     |     |        |        |     |     |       |       |      |      |        |        |        |        |       |       |      |      |     |     |      |      |     |     |      |      |             |             |           |           |             |             |     |     |      |      |         |         |       |       |       |       |              |              |      |      |    |    |          |          |     |     |           |           |         |         |      |      |     |     |       |       |     |     |              |              |                 |                 |
| ◎             | パッケージエアコン   |          |   |   |   |   |   |     |     |     |     |     |     |      |      |     |     |    |    |     |     |        |        |     |     |       |       |      |      |        |        |        |        |       |       |      |      |     |     |      |      |     |     |      |      |             |             |           |           |             |             |     |     |      |      |         |         |       |       |       |       |              |              |      |      |    |    |          |          |     |     |           |           |         |         |      |      |     |     |       |       |     |     |              |              |                 |                 |
| ・             | 空気調和機 (AHU)   |          |   |   |   |   |   |     |     |     |     |     |     |      |      |     |     |    |    |     |     |        |        |     |     |       |       |      |      |        |        |        |        |       |       |      |      |     |     |      |      |     |     |      |      |             |             |           |           |             |             |     |     |      |      |         |         |       |       |       |       |              |              |      |      |    |    |          |          |     |     |           |           |         |         |      |      |     |     |       |       |     |     |              |              |                 |                 |
| ・             | 冷却塔   |          |   |   |   |   |   |     |     |     |     |     |     |      |      |     |     |    |    |     |     |        |        |     |     |       |       |      |      |        |        |        |        |       |       |      |      |     |     |      |      |     |     |      |      |             |             |           |           |             |             |     |     |      |      |         |         |       |       |       |       |              |              |      |      |    |    |          |          |     |     |           |           |         |         |      |      |     |     |       |       |     |     |              |              |                 |                 |
| ・             | ヘッダー  |          |   |   |   |   |   |     |     |     |     |     |     |      |      |     |     |    |    |     |     |        |        |     |     |       |       |      |      |        |        |        |        |       |       |      |      |     |     |      |      |     |     |      |      |             |             |           |           |             |             |     |     |      |      |         |         |       |       |       |       |              |              |      |      |    |    |          |          |     |     |           |           |         |         |      |      |     |     |       |       |     |     |              |              |                 |                 |
| ・             | 自動制御機器類   |          |   |   |   |   |   |     |     |     |     |     |     |      |      |     |     |    |    |     |     |        |        |     |     |       |       |      |      |        |        |        |        |       |       |      |      |     |     |      |      |     |     |      |      |             |             |           |           |             |             |     |     |      |      |         |         |       |       |       |       |              |              |      |      |    |    |          |          |     |     |           |           |         |         |      |      |     |     |       |       |     |     |              |              |                 |                 |
| ・             | 中央監視盤   |          |   |   |   |   |   |     |     |     |     |     |     |      |      |     |     |    |    |     |     |        |        |     |     |       |       |      |      |        |        |        |        |       |       |      |      |     |     |      |      |     |     |      |      |             |             |           |           |             |             |     |     |      |      |         |         |       |       |       |       |              |              |      |      |    |    |          |          |     |     |           |           |         |         |      |      |     |     |       |       |     |     |              |              |                 |                 |
| ・             | リモート盤   |          |   |   |   |   |   |     |     |     |     |     |     |      |      |     |     |    |    |     |     |        |        |     |     |       |       |      |      |        |        |        |        |       |       |      |      |     |     |      |      |     |     |      |      |             |             |           |           |             |             |     |     |      |      |         |         |       |       |       |       |              |              |      |      |    |    |          |          |     |     |           |           |         |         |      |      |     |     |       |       |     |     |              |              |                 |                 |
| ・             | 給排水衛生設備工事用機材  |          |   |   |   |   |   |     |     |     |     |     |     |      |      |     |     |    |    |     |     |        |        |     |     |       |       |      |      |        |        |        |        |       |       |      |      |     |     |      |      |     |     |      |      |             |             |           |           |             |             |     |     |      |      |         |         |       |       |       |       |              |              |      |      |    |    |          |          |     |     |           |           |         |         |      |      |     |     |       |       |     |     |              |              |                 |                 |
| ◎             | 衛生器具  |          |   |   |   |   |   |     |     |     |     |     |     |      |      |     |     |    |    |     |     |        |        |     |     |       |       |      |      |        |        |        |        |       |       |      |      |     |     |      |      |     |     |      |      |             |             |           |           |             |             |     |     |      |      |         |         |       |       |       |       |              |              |      |      |    |    |          |          |     |     |           |           |         |         |      |      |     |     |       |       |     |     |              |              |                 |                 |
| ◎             | 水栓  |          |   |   |   |   |   |     |     |     |     |     |     |      |      |     |     |    |    |     |     |        |        |     |     |       |       |      |      |        |        |        |        |       |       |      |      |     |     |      |      |     |     |      |      |             |             |           |           |             |             |     |     |      |      |         |         |       |       |       |       |              |              |      |      |    |    |          |          |     |     |           |           |         |         |      |      |     |     |       |       |     |     |              |              |                 |                 |
| ◎             | 組立てマンホール  |          |   |   |   |   |   |     |     |     |     |     |     |      |      |     |     |    |    |     |     |        |        |     |     |       |       |      |      |        |        |        |        |       |       |      |      |     |     |      |      |     |     |      |      |             |             |           |           |             |             |     |     |      |      |         |         |       |       |       |       |              |              |      |      |    |    |          |          |     |     |           |           |         |         |      |      |     |     |       |       |     |     |              |              |                 |                 |
| ・             | 浄化槽   |          |   |   |   |   |   |     |     |     |     |     |     |      |      |     |     |    |    |     |     |        |        |     |     |       |       |      |      |        |        |        |        |       |       |      |      |     |     |      |      |     |     |      |      |             |             |           |           |             |             |     |     |      |      |         |         |       |       |       |       |              |              |      |      |    |    |          |          |     |     |           |           |         |         |      |      |     |     |       |       |     |     |              |              |                 |                 |
| ・             | F R P 浄化槽   |          |   |   |   |   |   |     |     |     |     |     |     |      |      |     |     |    |    |     |     |        |        |     |     |       |       |      |      |        |        |        |        |       |       |      |      |     |     |      |      |     |     |      |      |             |             |           |           |             |             |     |     |      |      |         |         |       |       |       |       |              |              |      |      |    |    |          |          |     |     |           |           |         |         |      |      |     |     |       |       |     |     |              |              |                 |                 |
| ・             | 動力盤、制御盤   |          |   |   |   |   |   |     |     |     |     |     |     |      |      |     |     |    |    |     |     |        |        |     |     |       |       |      |      |        |        |        |        |       |       |      |      |     |     |      |      |     |     |      |      |             |             |           |           |             |             |     |     |      |      |         |         |       |       |       |       |              |              |      |      |    |    |          |          |     |     |           |           |         |         |      |      |     |     |       |       |     |     |              |              |                 |                 |
| ・             | プロワー  |          |   |   |   |   |   |     |     |     |     |     |     |      |      |     |     |    |    |     |     |        |        |     |     |       |       |      |      |        |        |        |        |       |       |      |      |     |     |      |      |     |     |      |      |             |             |           |           |             |             |     |     |      |      |         |         |       |       |       |       |              |              |      |      |    |    |          |          |     |     |           |           |         |         |      |      |     |     |       |       |     |     |              |              |                 |                 |
| ・             | さく井   |          |   |   |   |   |   |     |     |     |     |     |     |      |      |     |     |    |    |     |     |        |        |     |     |       |       |      |      |        |        |        |        |       |       |      |      |     |     |      |      |     |     |      |      |             |             |           |           |             |             |     |     |      |      |         |         |       |       |       |       |              |              |      |      |    |    |          |          |     |     |           |           |         |         |      |      |     |     |       |       |     |     |              |              |                 |                 |
| ・             | スクリーン   |          |   |   |   |   |   |     |     |     |     |     |     |      |      |     |     |    |    |     |     |        |        |     |     |       |       |      |      |        |        |        |        |       |       |      |      |     |     |      |      |     |     |      |      |             |             |           |           |             |             |     |     |      |      |         |         |       |       |       |       |              |              |      |      |    |    |          |          |     |     |           |           |         |         |      |      |     |     |       |       |     |     |              |              |                 |                 |
| ・             | その他   |          |   |   |   |   |   |     |     |     |     |     |     |      |      |     |     |    |    |     |     |        |        |     |     |       |       |      |      |        |        |        |        |       |       |      |      |     |     |      |      |     |     |      |      |             |             |           |           |             |             |     |     |      |      |         |         |       |       |       |       |              |              |      |      |    |    |          |          |     |     |           |           |         |         |      |      |     |     |       |       |     |     |              |              |                 |                 |
| ◎             | スリーブ (つば付鋼管)  |          |   |   |   |   |   |     |     |     |     |     |     |      |      |     |     |    |    |     |     |        |        |     |     |       |       |      |      |        |        |        |        |       |       |      |      |     |     |      |      |     |     |      |      |             |             |           |           |             |             |     |     |      |      |         |         |       |       |       |       |              |              |      |      |    |    |          |          |     |     |           |           |         |         |      |      |     |     |       |       |     |     |              |              |                 |                 |
| ・             | ◎ 印の付いたものを適用する。   |          |   |   |   |   |   |     |     |     |     |     |     |      |      |     |     |    |    |     |     |        |        |     |     |       |       |      |      |        |        |        |        |       |       |      |      |     |     |      |      |     |     |      |      |             |             |           |           |             |             |     |     |      |      |         |         |       |       |       |       |              |              |      |      |    |    |          |          |     |     |           |           |         |         |      |      |     |     |       |       |     |     |              |              |                 |                 |
| 12 パネル落下防止措置  | 天井カセット型空調屋内機にはパネル落下防止措置を行う。<br>「防災拠点等における設備地震対策ガイドライン (静岡県)」による<br>パネル落下防止措置を行う。  | 2 配管保温外装 | 1 配管材料  | 屋内一般 ※ 配管用炭素鋼鋼管 (白)<br>・ 圧力配管用炭素鋼鋼管 (STPG370 白管 sch40)<br>・ 原則としてハウジング形継手は使用しない。<br>地中埋設 ※ 消火用硬質塩化ビニル外面被覆鋼管 (VS)<br>・ 消火用硬質塩化ビニル外面被覆鋼管 (STPG370VS 白管 sch40)   | <p>別表 1</p> <table border="1"> <tr><th>名</th><th>称</th></tr> <tr><td>◎</td><td>配管類</td></tr> <tr><td>◎</td><td>給水管</td></tr> <tr><td>◎</td><td>排水管</td></tr> <tr><td>◎</td><td>冷温水管</td></tr> <tr><td>◎</td><td>冷煤管</td></tr> <tr><td>・</td><td>弁類</td></tr> <tr><td>◎</td><td>仕切弁</td></tr> <tr><td>・</td><td>バタフライ弁</td></tr> <tr><td>◎</td><td>逆止弁</td></tr> <tr><td>◎</td><td>緊急遮断弁</td></tr> <tr><td>・</td><td>ポンプ類</td></tr> <tr><td>◎</td><td>給水用ポンプ</td></tr> <tr><td>・</td><td>空調用ポンプ</td></tr> <tr><td>・</td><td>消火ポンプ</td></tr> <tr><td>・</td><td>タンク類</td></tr> <tr><td>◎</td><td>受水槽</td></tr> <tr><td>・</td><td>高架水槽</td></tr> <tr><td>・</td><td>貯湯槽</td></tr> <tr><td>・</td><td>膨張水槽</td></tr> <tr><td>・</td><td>空気調和設備工事用機材</td></tr> <tr><td>◎</td><td>パッケージエアコン</td></tr> <tr><td>・</td><td>空気調和機 (AHU)</td></tr> <tr><td>・</td><td>冷却塔</td></tr> <tr><td>・</td><td>ヘッダー</td></tr> <tr><td>・</td><td>自動制御機器類</td></tr> <tr><td>・</td><td>中央監視盤</td></tr> <tr><td>・</td><td>リモート盤</td></tr> <tr><td>・</td><td>給排水衛生設備工事用機材</td></tr> <tr><td>◎</td><td>衛生器具</td></tr> <tr><td>◎</td><td>水栓</td></tr> <tr><td>◎</td><td>組立てマンホール</td></tr> <tr><td>・</td><td>浄化槽</td></tr> <tr><td>・</td><td>F R P 浄化槽</td></tr> <tr><td>・</td><td>動力盤、制御盤</td></tr> <tr><td>・</td><td>プロワー</td></tr> <tr><td>・</td><td>さく井</td></tr> <tr><td>・</td><td>スクリーン</td></tr> <tr><td>・</td><td>その他</td></tr> <tr><td>◎</td><td>スリーブ (つば付鋼管)</td></tr> <tr><td>・</td><td>◎ 印の付いたものを適用する。</td></tr> </table> | 名   | 称 | ◎   | 配管類 | ◎   | 給水管 | ◎   | 排水管 | ◎    | 冷温水管 | ◎   | 冷煤管 | ・  | 弁類 | ◎   | 仕切弁 | ・      | バタフライ弁 | ◎   | 逆止弁 | ◎     | 緊急遮断弁 | ・    | ポンプ類 | ◎      | 給水用ポンプ | ・      | 空調用ポンプ | ・     | 消火ポンプ | ・    | タンク類 | ◎   | 受水槽 | ・    | 高架水槽 | ・   | 貯湯槽 | ・    | 膨張水槽 | ・           | 空気調和設備工事用機材 | ◎         | パッケージエアコン | ・           | 空気調和機 (AHU) | ・   | 冷却塔 | ・    | ヘッダー | ・       | 自動制御機器類 | ・     | 中央監視盤 | ・     | リモート盤 | ・            | 給排水衛生設備工事用機材 | ◎    | 衛生器具 | ◎  | 水栓 | ◎        | 組立てマンホール | ・   | 浄化槽 | ・         | F R P 浄化槽 | ・       | 動力盤、制御盤 | ・    | プロワー | ・   | さく井 | ・     | スクリーン | ・   | その他 | ◎            | スリーブ (つば付鋼管) | ・               | ◎ 印の付いたものを適用する。 |
| 名             | 称   |          |   |   |   |   |   |     |     |     |     |     |     |      |      |     |     |    |    |     |     |        |        |     |     |       |       |      |      |        |        |        |        |       |       |      |      |     |     |      |      |     |     |      |      |             |             |           |           |             |             |     |     |      |      |         |         |       |       |       |       |              |              |      |      |    |    |          |          |     |     |           |           |         |         |      |      |     |     |       |       |     |     |              |              |                 |                 |
| ◎             | 配管類   |          |   |   |   |   |   |     |     |     |     |     |     |      |      |     |     |    |    |     |     |        |        |     |     |       |       |      |      |        |        |        |        |       |       |      |      |     |     |      |      |     |     |      |      |             |             |           |           |             |             |     |     |      |      |         |         |       |       |       |       |              |              |      |      |    |    |          |          |     |     |           |           |         |         |      |      |     |     |       |       |     |     |              |              |                 |                 |
| ◎             | 給水管   |          |   |   |   |   |   |     |     |     |     |     |     |      |      |     |     |    |    |     |     |        |        |     |     |       |       |      |      |        |        |        |        |       |       |      |      |     |     |      |      |     |     |      |      |             |             |           |           |             |             |     |     |      |      |         |         |       |       |       |       |              |              |      |      |    |    |          |          |     |     |           |           |         |         |      |      |     |     |       |       |     |     |              |              |                 |                 |
| ◎             | 排水管   |          |   |   |   |   |   |     |     |     |     |     |     |      |      |     |     |    |    |     |     |        |        |     |     |       |       |      |      |        |        |        |        |       |       |      |      |     |     |      |      |     |     |      |      |             |             |           |           |             |             |     |     |      |      |         |         |       |       |       |       |              |              |      |      |    |    |          |          |     |     |           |           |         |         |      |      |     |     |       |       |     |     |              |              |                 |                 |
| ◎             | 冷温水管  |          |   |   |   |   |   |     |     |     |     |     |     |      |      |     |     |    |    |     |     |        |        |     |     |       |       |      |      |        |        |        |        |       |       |      |      |     |     |      |      |     |     |      |      |             |             |           |           |             |             |     |     |      |      |         |         |       |       |       |       |              |              |      |      |    |    |          |          |     |     |           |           |         |         |      |      |     |     |       |       |     |     |              |              |                 |                 |
| ◎             | 冷煤管   |          |   |   |   |   |   |     |     |     |     |     |     |      |      |     |     |    |    |     |     |        |        |     |     |       |       |      |      |        |        |        |        |       |       |      |      |     |     |      |      |     |     |      |      |             |             |           |           |             |             |     |     |      |      |         |         |       |       |       |       |              |              |      |      |    |    |          |          |     |     |           |           |         |         |      |      |     |     |       |       |     |     |              |              |                 |                 |
| ・             | 弁類  |          |   |   |   |   |   |     |     |     |     |     |     |      |      |     |     |    |    |     |     |        |        |     |     |       |       |      |      |        |        |        |        |       |       |      |      |     |     |      |      |     |     |      |      |             |             |           |           |             |             |     |     |      |      |         |         |       |       |       |       |              |              |      |      |    |    |          |          |     |     |           |           |         |         |      |      |     |     |       |       |     |     |              |              |                 |                 |
| ◎             | 仕切弁   |          |   |   |   |   |   |     |     |     |     |     |     |      |      |     |     |    |    |     |     |        |        |     |     |       |       |      |      |        |        |        |        |       |       |      |      |     |     |      |      |     |     |      |      |             |             |           |           |             |             |     |     |      |      |         |         |       |       |       |       |              |              |      |      |    |    |          |          |     |     |           |           |         |         |      |      |     |     |       |       |     |     |              |              |                 |                 |
| ・             | バタフライ弁  |          |   |   |   |   |   |     |     |     |     |     |     |      |      |     |     |    |    |     |     |        |        |     |     |       |       |      |      |        |        |        |        |       |       |      |      |     |     |      |      |     |     |      |      |             |             |           |           |             |             |     |     |      |      |         |         |       |       |       |       |              |              |      |      |    |    |          |          |     |     |           |           |         |         |      |      |     |     |       |       |     |     |              |              |                 |                 |
| ◎             | 逆止弁   |          |   |   |   |   |   |     |     |     |     |     |     |      |      |     |     |    |    |     |     |        |        |     |     |       |       |      |      |        |        |        |        |       |       |      |      |     |     |      |      |     |     |      |      |             |             |           |           |             |             |     |     |      |      |         |         |       |       |       |       |              |              |      |      |    |    |          |          |     |     |           |           |         |         |      |      |     |     |       |       |     |     |              |              |                 |                 |
| ◎             | 緊急遮断弁   |          |   |   |   |   |   |     |     |     |     |     |     |      |      |     |     |    |    |     |     |        |        |     |     |       |       |      |      |        |        |        |        |       |       |      |      |     |     |      |      |     |     |      |      |             |             |           |           |             |             |     |     |      |      |         |         |       |       |       |       |              |              |      |      |    |    |          |          |     |     |           |           |         |         |      |      |     |     |       |       |     |     |              |              |                 |                 |
| ・             | ポンプ類  |          |   |   |   |   |   |     |     |     |     |     |     |      |      |     |     |    |    |     |     |        |        |     |     |       |       |      |      |        |        |        |        |       |       |      |      |     |     |      |      |     |     |      |      |             |             |           |           |             |             |     |     |      |      |         |         |       |       |       |       |              |              |      |      |    |    |          |          |     |     |           |           |         |         |      |      |     |     |       |       |     |     |              |              |                 |                 |
| ◎             | 給水用ポンプ  |          |   |   |   |   |   |     |     |     |     |     |     |      |      |     |     |    |    |     |     |        |        |     |     |       |       |      |      |        |        |        |        |       |       |      |      |     |     |      |      |     |     |      |      |             |             |           |           |             |             |     |     |      |      |         |         |       |       |       |       |              |              |      |      |    |    |          |          |     |     |           |           |         |         |      |      |     |     |       |       |     |     |              |              |                 |                 |
| ・             | 空調用ポンプ  |          |   |   |   |   |   |     |     |     |     |     |     |      |      |     |     |    |    |     |     |        |        |     |     |       |       |      |      |        |        |        |        |       |       |      |      |     |     |      |      |     |     |      |      |             |             |           |           |             |             |     |     |      |      |         |         |       |       |       |       |              |              |      |      |    |    |          |          |     |     |           |           |         |         |      |      |     |     |       |       |     |     |              |              |                 |                 |
| ・             | 消火ポンプ   |          |   |   |   |   |   |     |     |     |     |     |     |      |      |     |     |    |    |     |     |        |        |     |     |       |       |      |      |        |        |        |        |       |       |      |      |     |     |      |      |     |     |      |      |             |             |           |           |             |             |     |     |      |      |         |         |       |       |       |       |              |              |      |      |    |    |          |          |     |     |           |           |         |         |      |      |     |     |       |       |     |     |              |              |                 |                 |
| ・             | タンク類  |          |   |   |   |   |   |     |     |     |     |     |     |      |      |     |     |    |    |     |     |        |        |     |     |       |       |      |      |        |        |        |        |       |       |      |      |     |     |      |      |     |     |      |      |             |             |           |           |             |             |     |     |      |      |         |         |       |       |       |       |              |              |      |      |    |    |          |          |     |     |           |           |         |         |      |      |     |     |       |       |     |     |              |              |                 |                 |
| ◎             | 受水槽   |          |   |   |   |   |   |     |     |     |     |     |     |      |      |     |     |    |    |     |     |        |        |     |     |       |       |      |      |        |        |        |        |       |       |      |      |     |     |      |      |     |     |      |      |             |             |           |           |             |             |     |     |      |      |         |         |       |       |       |       |              |              |      |      |    |    |          |          |     |     |           |           |         |         |      |      |     |     |       |       |     |     |              |              |                 |                 |
| ・             | 高架水槽  |          |   |   |   |   |   |     |     |     |     |     |     |      |      |     |     |    |    |     |     |        |        |     |     |       |       |      |      |        |        |        |        |       |       |      |      |     |     |      |      |     |     |      |      |             |             |           |           |             |             |     |     |      |      |         |         |       |       |       |       |              |              |      |      |    |    |          |          |     |     |           |           |         |         |      |      |     |     |       |       |     |     |              |              |                 |                 |
| ・             | 貯湯槽   |          |   |   |   |   |   |     |     |     |     |     |     |      |      |     |     |    |    |     |     |        |        |     |     |       |       |      |      |        |        |        |        |       |       |      |      |     |     |      |      |     |     |      |      |             |             |           |           |             |             |     |     |      |      |         |         |       |       |       |       |              |              |      |      |    |    |          |          |     |     |           |           |         |         |      |      |     |     |       |       |     |     |              |              |                 |                 |
| ・             | 膨張水槽  |          |   |   |   |   |   |     |     |     |     |     |     |      |      |     |     |    |    |     |     |        |        |     |     |       |       |      |      |        |        |        |        |       |       |      |      |     |     |      |      |     |     |      |      |             |             |           |           |             |             |     |     |      |      |         |         |       |       |       |       |              |              |      |      |    |    |          |          |     |     |           |           |         |         |      |      |     |     |       |       |     |     |              |              |                 |                 |
| ・             | 空気調和設備工事用機材   |          |   |   |   |   |   |     |     |     |     |     |     |      |      |     |     |    |    |     |     |        |        |     |     |       |       |      |      |        |        |        |        |       |       |      |      |     |     |      |      |     |     |      |      |             |             |           |           |             |             |     |     |      |      |         |         |       |       |       |       |              |              |      |      |    |    |          |          |     |     |           |           |         |         |      |      |     |     |       |       |     |     |              |              |                 |                 |
| ◎             | パッケージエアコン   |          |   |   |   |   |   |     |     |     |     |     |     |      |      |     |     |    |    |     |     |        |        |     |     |       |       |      |      |        |        |        |        |       |       |      |      |     |     |      |      |     |     |      |      |             |             |           |           |             |             |     |     |      |      |         |         |       |       |       |       |              |              |      |      |    |    |          |          |     |     |           |           |         |         |      |      |     |     |       |       |     |     |              |              |                 |                 |
| ・             | 空気調和機 (AHU)   |          |   |   |   |   |   |     |     |     |     |     |     |      |      |     |     |    |    |     |     |        |        |     |     |       |       |      |      |        |        |        |        |       |       |      |      |     |     |      |      |     |     |      |      |             |             |           |           |             |             |     |     |      |      |         |         |       |       |       |       |              |              |      |      |    |    |          |          |     |     |           |           |         |         |      |      |     |     |       |       |     |     |              |              |                 |                 |
| ・             | 冷却塔   |          |   |   |   |   |   |     |     |     |     |     |     |      |      |     |     |    |    |     |     |        |        |     |     |       |       |      |      |        |        |        |        |       |       |      |      |     |     |      |      |     |     |      |      |             |             |           |           |             |             |     |     |      |      |         |         |       |       |       |       |              |              |      |      |    |    |          |          |     |     |           |           |         |         |      |      |     |     |       |       |     |     |              |              |                 |                 |
| ・             | ヘッダー  |          |   |   |   |   |   |     |     |     |     |     |     |      |      |     |     |    |    |     |     |        |        |     |     |       |       |      |      |        |        |        |        |       |       |      |      |     |     |      |      |     |     |      |      |             |             |           |           |             |             |     |     |      |      |         |         |       |       |       |       |              |              |      |      |    |    |          |          |     |     |           |           |         |         |      |      |     |     |       |       |     |     |              |              |                 |                 |
| ・             | 自動制御機器類   |          |   |   |   |   |   |     |     |     |     |     |     |      |      |     |     |    |    |     |     |        |        |     |     |       |       |      |      |        |        |        |        |       |       |      |      |     |     |      |      |     |     |      |      |             |             |           |           |             |             |     |     |      |      |         |         |       |       |       |       |              |              |      |      |    |    |          |          |     |     |           |           |         |         |      |      |     |     |       |       |     |     |              |              |                 |                 |
| ・             | 中央監視盤   |          |   |   |   |   |   |     |     |     |     |     |     |      |      |     |     |    |    |     |     |        |        |     |     |       |       |      |      |        |        |        |        |       |       |      |      |     |     |      |      |     |     |      |      |             |             |           |           |             |             |     |     |      |      |         |         |       |       |       |       |              |              |      |      |    |    |          |          |     |     |           |           |         |         |      |      |     |     |       |       |     |     |              |              |                 |                 |
| ・             | リモート盤   |          |   |   |   |   |   |     |     |     |     |     |     |      |      |     |     |    |    |     |     |        |        |     |     |       |       |      |      |        |        |        |        |       |       |      |      |     |     |      |      |     |     |      |      |             |             |           |           |             |             |     |     |      |      |         |         |       |       |       |       |              |              |      |      |    |    |          |          |     |     |           |           |         |         |      |      |     |     |       |       |     |     |              |              |                 |                 |
| ・             | 給排水衛生設備工事用機材  |          |   |   |   |   |   |     |     |     |     |     |     |      |      |     |     |    |    |     |     |        |        |     |     |       |       |      |      |        |        |        |        |       |       |      |      |     |     |      |      |     |     |      |      |             |             |           |           |             |             |     |     |      |      |         |         |       |       |       |       |              |              |      |      |    |    |          |          |     |     |           |           |         |         |      |      |     |     |       |       |     |     |              |              |                 |                 |
| ◎             | 衛生器具  |          |   |   |   |   |   |     |     |     |     |     |     |      |      |     |     |    |    |     |     |        |        |     |     |       |       |      |      |        |        |        |        |       |       |      |      |     |     |      |      |     |     |      |      |             |             |           |           |             |             |     |     |      |      |         |         |       |       |       |       |              |              |      |      |    |    |          |          |     |     |           |           |         |         |      |      |     |     |       |       |     |     |              |              |                 |                 |
| ◎             | 水栓  |          |   |   |   |   |   |     |     |     |     |     |     |      |      |     |     |    |    |     |     |        |        |     |     |       |       |      |      |        |        |        |        |       |       |      |      |     |     |      |      |     |     |      |      |             |             |           |           |             |             |     |     |      |      |         |         |       |       |       |       |              |              |      |      |    |    |          |          |     |     |           |           |         |         |      |      |     |     |       |       |     |     |              |              |                 |                 |
| ◎             | 組立てマンホール  |          |   |   |   |   |   |     |     |     |     |     |     |      |      |     |     |    |    |     |     |        |        |     |     |       |       |      |      |        |        |        |        |       |       |      |      |     |     |      |      |     |     |      |      |             |             |           |           |             |             |     |     |      |      |         |         |       |       |       |       |              |              |      |      |    |    |          |          |     |     |           |           |         |         |      |      |     |     |       |       |     |     |              |              |                 |                 |
| ・             | 浄化槽   |          |   |   |   |   |   |     |     |     |     |     |     |      |      |     |     |    |    |     |     |        |        |     |     |       |       |      |      |        |        |        |        |       |       |      |      |     |     |      |      |     |     |      |      |             |             |           |           |             |             |     |     |      |      |         |         |       |       |       |       |              |              |      |      |    |    |          |          |     |     |           |           |         |         |      |      |     |     |       |       |     |     |              |              |                 |                 |
| ・             | F R P 浄化槽   |          |   |   |   |   |   |     |     |     |     |     |     |      |      |     |     |    |    |     |     |        |        |     |     |       |       |      |      |        |        |        |        |       |       |      |      |     |     |      |      |     |     |      |      |             |             |           |           |             |             |     |     |      |      |         |         |       |       |       |       |              |              |      |      |    |    |          |          |     |     |           |           |         |         |      |      |     |     |       |       |     |     |              |              |                 |                 |
| ・             | 動力盤、制御盤   |          |   |   |   |   |   |     |     |     |     |     |     |      |      |     |     |    |    |     |     |        |        |     |     |       |       |      |      |        |        |        |        |       |       |      |      |     |     |      |      |     |     |      |      |             |             |           |           |             |             |     |     |      |      |         |         |       |       |       |       |              |              |      |      |    |    |          |          |     |     |           |           |         |         |      |      |     |     |       |       |     |     |              |              |                 |                 |
| ・             | プロワー  |          |   |   |   |   |   |     |     |     |     |     |     |      |      |     |     |    |    |     |     |        |        |     |     |       |       |      |      |        |        |        |        |       |       |      |      |     |     |      |      |     |     |      |      |             |             |           |           |             |             |     |     |      |      |         |         |       |       |       |       |              |              |      |      |    |    |          |          |     |     |           |           |         |         |      |      |     |     |       |       |     |     |              |              |                 |                 |
| ・             | さく井   |          |   |   |   |   |   |     |     |     |     |     |     |      |      |     |     |    |    |     |     |        |        |     |     |       |       |      |      |        |        |        |        |       |       |      |      |     |     |      |      |     |     |      |      |             |             |           |           |             |             |     |     |      |      |         |         |       |       |       |       |              |              |      |      |    |    |          |          |     |     |           |           |         |         |      |      |     |     |       |       |     |     |              |              |                 |                 |
| ・             | スクリーン   |          |   |   |   |   |   |     |     |     |     |     |     |      |      |     |     |    |    |     |     |        |        |     |     |       |       |      |      |        |        |        |        |       |       |      |      |     |     |      |      |     |     |      |      |             |             |           |           |             |             |     |     |      |      |         |         |       |       |       |       |              |              |      |      |    |    |          |          |     |     |           |           |         |         |      |      |     |     |       |       |     |     |              |              |                 |                 |
| ・             | その他   |          |   |   |   |   |   |     |     |     |     |     |     |      |      |     |     |    |    |     |     |        |        |     |     |       |       |      |      |        |        |        |        |       |       |      |      |     |     |      |      |     |     |      |      |             |             |           |           |             |             |     |     |      |      |         |         |       |       |       |       |              |              |      |      |    |    |          |          |     |     |           |           |         |         |      |      |     |     |       |       |     |     |              |              |                 |                 |
| ◎             | スリーブ (つば付鋼管)  |          |   |   |   |   |   |     |     |     |     |     |     |      |      |     |     |    |    |     |     |        |        |     |     |       |       |      |      |        |        |        |        |       |       |      |      |     |     |      |      |     |     |      |      |             |             |           |           |             |             |     |     |      |      |         |         |       |       |       |       |              |              |      |      |    |    |          |          |     |     |           |           |         |         |      |      |     |     |       |       |     |     |              |              |                 |                 |
| ・             | ◎ 印の付いたものを適用する。   |          |   |   |   |   |   |     |     |     |     |     |     |      |      |     |     |    |    |     |     |        |        |     |     |       |       |      |      |        |        |        |        |       |       |      |      |     |     |      |      |     |     |      |      |             |             |           |           |             |             |     |     |      |      |         |         |       |       |       |       |              |              |      |      |    |    |          |          |     |     |           |           |         |         |      |      |     |     |       |       |     |     |              |              |                 |                 |
| 13 既存ダクトの再利用  | 改修標準仕様書第3編2. 2. 7 「既設ダクトの再利用」による。<br>ダクト内清掃 ※ 行わない ・ 行う   | 消火設備     | 1 配管材料  | 屋内一般 ※ 配管用炭素鋼鋼管 (白)<br>・ 圧力配管用炭素鋼鋼管 (STPG370 白管 sch40)<br>・ 原則としてハウジング形継手は使用しない。<br>地中埋設 ※ 消火用硬質塩化ビニル外面被覆鋼管 (VS)<br>・ 消火用硬質塩化ビニル外面被覆鋼管 (STPG370VS 白管 sch40)   | <p>別表 1</p> <table border="1"> <tr><th>名</th><th>称</th></tr> <tr><td>◎</td><td>配管類</td></tr> <tr><td>◎</td><td>給水管</td></tr> <tr><td>◎</td><td>排水管</td></tr> <tr><td>◎</td><td>冷温水管</td></tr> <tr><td>◎</td><td>冷煤管</td></tr> <tr><td>・</td><td>弁類</td></tr> <tr><td>◎</td><td>仕切弁</td></tr> <tr><td>・</td><td>バタフライ弁</td></tr> <tr><td>◎</td><td>逆止弁</td></tr> <tr><td>◎</td><td>緊急遮断弁</td></tr> <tr><td>・</td><td>ポンプ類</td></tr> <tr><td>◎</td><td>給水用ポンプ</td></tr> <tr><td>・</td><td>空調用ポンプ</td></tr> <tr><td>・</td><td>消火ポンプ</td></tr> <tr><td>・</td><td>タンク類</td></tr> <tr><td>◎</td><td>受水槽</td></tr> <tr><td>・</td><td>高架水槽</td></tr> <tr><td>・</td><td>貯湯槽</td></tr> <tr><td>・</td><td>膨張水槽</td></tr> <tr><td>・</td><td>空気調和設備工事用機材</td></tr> <tr><td>◎</td><td>パッケージエアコン</td></tr> <tr><td>・</td><td>空気調和機 (AHU)</td></tr> <tr><td>・</td><td>冷却塔</td></tr> <tr><td>・</td><td>ヘッダー</td></tr> <tr><td>・</td><td>自動制御機器類</td></tr> <tr><td>・</td><td>中央監視盤</td></tr> <tr><td>・</td><td>リモート盤</td></tr> <tr><td>・</td><td>給排水衛生設備工事用機材</td></tr> <tr><td>◎</td><td>衛生器具</td></tr> <tr><td>◎</td><td>水栓</td></tr> <tr><td>◎</td><td>組立てマンホール</td></tr> <tr><td>・</td><td>浄化槽</td></tr> <tr><td>・</td><td>F R P 浄化槽</td></tr> <tr><td>・</td><td>動力盤、制御盤</td></tr> <tr><td>・</td><td>プロワー</td></tr> <tr><td>・</td><td>さく井</td></tr> <tr><td>・</td><td>スクリーン</td></tr> <tr><td>・</td><td>その他</td></tr> <tr><td>◎</td><td>スリーブ (つば付鋼管)</td></tr> <tr><td>・</td><td>◎ 印の付いたものを適用する。</td></tr> </table> | 名   | 称 | ◎   | 配管類 | ◎   | 給水管 | ◎   | 排水管 | ◎    | 冷温水管 | ◎   | 冷煤管 | ・  | 弁類 | ◎   | 仕切弁 | ・      | バタフライ弁 | ◎   | 逆止弁 | ◎     | 緊急遮断弁 | ・    | ポンプ類 | ◎      | 給水用ポンプ | ・      | 空調用ポンプ | ・     | 消火ポンプ | ・    | タンク類 | ◎   | 受水槽 | ・    | 高架水槽 | ・   | 貯湯槽 | ・    | 膨張水槽 | ・           | 空気調和設備工事用機材 | ◎         | パッケージエアコン | ・           | 空気調和機 (AHU) | ・   | 冷却塔 | ・    | ヘッダー | ・       | 自動制御機器類 | ・     | 中央監視盤 | ・     | リモート盤 | ・            | 給排水衛生設備工事用機材 | ◎    | 衛生器具 | ◎  | 水栓 | ◎        | 組立てマンホール | ・   | 浄化槽 | ・         | F R P 浄化槽 | ・       | 動力盤、制御盤 | ・    | プロワー | ・   | さく井 | ・     | スクリーン | ・   | その他 | ◎            | スリーブ (つば付鋼管) | ・               | ◎ 印の付いたものを適用する。 |
| 名             | 称   |          |   |   |   |   |   |     |     |     |     |     |     |      |      |     |     |    |    |     |     |        |        |     |     |       |       |      |      |        |        |        |        |       |       |      |      |     |     |      |      |     |     |      |      |             |             |           |           |             |             |     |     |      |      |         |         |       |       |       |       |              |              |      |      |    |    |          |          |     |     |           |           |         |         |      |      |     |     |       |       |     |     |              |              |                 |                 |
| ◎             | 配管類   |          |   |   |   |   |   |     |     |     |     |     |     |      |      |     |     |    |    |     |     |        |        |     |     |       |       |      |      |        |        |        |        |       |       |      |      |     |     |      |      |     |     |      |      |             |             |           |           |             |             |     |     |      |      |         |         |       |       |       |       |              |              |      |      |    |    |          |          |     |     |           |           |         |         |      |      |     |     |       |       |     |     |              |              |                 |                 |
| ◎             | 給水管   |          |   |   |   |   |   |     |     |     |     |     |     |      |      |     |     |    |    |     |     |        |        |     |     |       |       |      |      |        |        |        |        |       |       |      |      |     |     |      |      |     |     |      |      |             |             |           |           |             |             |     |     |      |      |         |         |       |       |       |       |              |              |      |      |    |    |          |          |     |     |           |           |         |         |      |      |     |     |       |       |     |     |              |              |                 |                 |
| ◎             | 排水管   |          |   |   |   |   |   |     |     |     |     |     |     |      |      |     |     |    |    |     |     |        |        |     |     |       |       |      |      |        |        |        |        |       |       |      |      |     |     |      |      |     |     |      |      |             |             |           |           |             |             |     |     |      |      |         |         |       |       |       |       |              |              |      |      |    |    |          |          |     |     |           |           |         |         |      |      |     |     |       |       |     |     |              |              |                 |                 |
| ◎             | 冷温水管  |          |   |   |   |   |   |     |     |     |     |     |     |      |      |     |     |    |    |     |     |        |        |     |     |       |       |      |      |        |        |        |        |       |       |      |      |     |     |      |      |     |     |      |      |             |             |           |           |             |             |     |     |      |      |         |         |       |       |       |       |              |              |      |      |    |    |          |          |     |     |           |           |         |         |      |      |     |     |       |       |     |     |              |              |                 |                 |
| ◎             | 冷煤管   |          |   |   |   |   |   |     |     |     |     |     |     |      |      |     |     |    |    |     |     |        |        |     |     |       |       |      |      |        |        |        |        |       |       |      |      |     |     |      |      |     |     |      |      |             |             |           |           |             |             |     |     |      |      |         |         |       |       |       |       |              |              |      |      |    |    |          |          |     |     |           |           |         |         |      |      |     |     |       |       |     |     |              |              |                 |                 |
| ・             | 弁類  |          |   |   |   |   |   |     |     |     |     |     |     |      |      |     |     |    |    |     |     |        |        |     |     |       |       |      |      |        |        |        |        |       |       |      |      |     |     |      |      |     |     |      |      |             |             |           |           |             |             |     |     |      |      |         |         |       |       |       |       |              |              |      |      |    |    |          |          |     |     |           |           |         |         |      |      |     |     |       |       |     |     |              |              |                 |                 |
| ◎             | 仕切弁   |          |   |   |   |   |   |     |     |     |     |     |     |      |      |     |     |    |    |     |     |        |        |     |     |       |       |      |      |        |        |        |        |       |       |      |      |     |     |      |      |     |     |      |      |             |             |           |           |             |             |     |     |      |      |         |         |       |       |       |       |              |              |      |      |    |    |          |          |     |     |           |           |         |         |      |      |     |     |       |       |     |     |              |              |                 |                 |
| ・             | バタフライ弁  |          |   |   |   |   |   |     |     |     |     |     |     |      |      |     |     |    |    |     |     |        |        |     |     |       |       |      |      |        |        |        |        |       |       |      |      |     |     |      |      |     |     |      |      |             |             |           |           |             |             |     |     |      |      |         |         |       |       |       |       |              |              |      |      |    |    |          |          |     |     |           |           |         |         |      |      |     |     |       |       |     |     |              |              |                 |                 |
| ◎             | 逆止弁   |          |   |   |   |   |   |     |     |     |     |     |     |      |      |     |     |    |    |     |     |        |        |     |     |       |       |      |      |        |        |        |        |       |       |      |      |     |     |      |      |     |     |      |      |             |             |           |           |             |             |     |     |      |      |         |         |       |       |       |       |              |              |      |      |    |    |          |          |     |     |           |           |         |         |      |      |     |     |       |       |     |     |              |              |                 |                 |
| ◎             | 緊急遮断弁   |          |   |   |   |   |   |     |     |     |     |     |     |      |      |     |     |    |    |     |     |        |        |     |     |       |       |      |      |        |        |        |        |       |       |      |      |     |     |      |      |     |     |      |      |             |             |           |           |             |             |     |     |      |      |         |         |       |       |       |       |              |              |      |      |    |    |          |          |     |     |           |           |         |         |      |      |     |     |       |       |     |     |              |              |                 |                 |
| ・             | ポンプ類  |          |   |   |   |   |   |     |     |     |     |     |     |      |      |     |     |    |    |     |     |        |        |     |     |       |       |      |      |        |        |        |        |       |       |      |      |     |     |      |      |     |     |      |      |             |             |           |           |             |             |     |     |      |      |         |         |       |       |       |       |              |              |      |      |    |    |          |          |     |     |           |           |         |         |      |      |     |     |       |       |     |     |              |              |                 |                 |
| ◎             | 給水用ポンプ  |          |   |   |   |   |   |     |     |     |     |     |     |      |      |     |     |    |    |     |     |        |        |     |     |       |       |      |      |        |        |        |        |       |       |      |      |     |     |      |      |     |     |      |      |             |             |           |           |             |             |     |     |      |      |         |         |       |       |       |       |              |              |      |      |    |    |          |          |     |     |           |           |         |         |      |      |     |     |       |       |     |     |              |              |                 |                 |
| ・             | 空調用ポンプ  |          |   |   |   |   |   |     |     |     |     |     |     |      |      |     |     |    |    |     |     |        |        |     |     |       |       |      |      |        |        |        |        |       |       |      |      |     |     |      |      |     |     |      |      |             |             |           |           |             |             |     |     |      |      |         |         |       |       |       |       |              |              |      |      |    |    |          |          |     |     |           |           |         |         |      |      |     |     |       |       |     |     |              |              |                 |                 |
| ・             | 消火ポンプ   |          |   |   |   |   |   |     |     |     |     |     |     |      |      |     |     |    |    |     |     |        |        |     |     |       |       |      |      |        |        |        |        |       |       |      |      |     |     |      |      |     |     |      |      |             |             |           |           |             |             |     |     |      |      |         |         |       |       |       |       |              |              |      |      |    |    |          |          |     |     |           |           |         |         |      |      |     |     |       |       |     |     |              |              |                 |                 |
| ・             | タンク類  |          |   |   |   |   |   |     |     |     |     |     |     |      |      |     |     |    |    |     |     |        |        |     |     |       |       |      |      |        |        |        |        |       |       |      |      |     |     |      |      |     |     |      |      |             |             |           |           |             |             |     |     |      |      |         |         |       |       |       |       |              |              |      |      |    |    |          |          |     |     |           |           |         |         |      |      |     |     |       |       |     |     |              |              |                 |                 |
| ◎             | 受水槽   |          |   |   |   |   |   |     |     |     |     |     |     |      |      |     |     |    |    |     |     |        |        |     |     |       |       |      |      |        |        |        |        |       |       |      |      |     |     |      |      |     |     |      |      |             |             |           |           |             |             |     |     |      |      |         |         |       |       |       |       |              |              |      |      |    |    |          |          |     |     |           |           |         |         |      |      |     |     |       |       |     |     |              |              |                 |                 |
| ・             | 高架水槽  |          |   |   |   |   |   |     |     |     |     |     |     |      |      |     |     |    |    |     |     |        |        |     |     |       |       |      |      |        |        |        |        |       |       |      |      |     |     |      |      |     |     |      |      |             |             |           |           |             |             |     |     |      |      |         |         |       |       |       |       |              |              |      |      |    |    |          |          |     |     |           |           |         |         |      |      |     |     |       |       |     |     |              |              |                 |                 |
| ・             | 貯湯槽   |          |   |   |   |   |   |     |     |     |     |     |     |      |      |     |     |    |    |     |     |        |        |     |     |       |       |      |      |        |        |        |        |       |       |      |      |     |     |      |      |     |     |      |      |             |             |           |           |             |             |     |     |      |      |         |         |       |       |       |       |              |              |      |      |    |    |          |          |     |     |           |           |         |         |      |      |     |     |       |       |     |     |              |              |                 |                 |
| ・             | 膨張水槽  |          |   |   |   |   |   |     |     |     |     |     |     |      |      |     |     |    |    |     |     |        |        |     |     |       |       |      |      |        |        |        |        |       |       |      |      |     |     |      |      |     |     |      |      |             |             |           |           |             |             |     |     |      |      |         |         |       |       |       |       |              |              |      |      |    |    |          |          |     |     |           |           |         |         |      |      |     |     |       |       |     |     |              |              |                 |                 |
| ・             | 空気調和設備工事用機材   |          |   |   |   |   |   |     |     |     |     |     |     |      |      |     |     |    |    |     |     |        |        |     |     |       |       |      |      |        |        |        |        |       |       |      |      |     |     |      |      |     |     |      |      |             |             |           |           |             |             |     |     |      |      |         |         |       |       |       |       |              |              |      |      |    |    |          |          |     |     |           |           |         |         |      |      |     |     |       |       |     |     |              |              |                 |                 |
| ◎             | パッケージエアコン   |          |   |   |   |   |   |     |     |     |     |     |     |      |      |     |     |    |    |     |     |        |        |     |     |       |       |      |      |        |        |        |        |       |       |      |      |     |     |      |      |     |     |      |      |             |             |           |           |             |             |     |     |      |      |         |         |       |       |       |       |              |              |      |      |    |    |          |          |     |     |           |           |         |         |      |      |     |     |       |       |     |     |              |              |                 |                 |
| ・             | 空気調和機 (AHU)   |          |   |   |   |   |   |     |     |     |     |     |     |      |      |     |     |    |    |     |     |        |        |     |     |       |       |      |      |        |        |        |        |       |       |      |      |     |     |      |      |     |     |      |      |             |             |           |           |             |             |     |     |      |      |         |         |       |       |       |       |              |              |      |      |    |    |          |          |     |     |           |           |         |         |      |      |     |     |       |       |     |     |              |              |                 |                 |
| ・             | 冷却塔   |          |   |   |   |   |   |     |     |     |     |     |     |      |      |     |     |    |    |     |     |        |        |     |     |       |       |      |      |        |        |        |        |       |       |      |      |     |     |      |      |     |     |      |      |             |             |           |           |             |             |     |     |      |      |         |         |       |       |       |       |              |              |      |      |    |    |          |          |     |     |           |           |         |         |      |      |     |     |       |       |     |     |              |              |                 |                 |
| ・             | ヘッダー  |          |   |   |   |   |   |     |     |     |     |     |     |      |      |     |     |    |    |     |     |        |        |     |     |       |       |      |      |        |        |        |        |       |       |      |      |     |     |      |      |     |     |      |      |             |             |           |           |             |             |     |     |      |      |         |         |       |       |       |       |              |              |      |      |    |    |          |          |     |     |           |           |         |         |      |      |     |     |       |       |     |     |              |              |                 |                 |
| ・             | 自動制御機器類   |          |   |   |   |   |   |     |     |     |     |     |     |      |      |     |     |    |    |     |     |        |        |     |     |       |       |      |      |        |        |        |        |       |       |      |      |     |     |      |      |     |     |      |      |             |             |           |           |             |             |     |     |      |      |         |         |       |       |       |       |              |              |      |      |    |    |          |          |     |     |           |           |         |         |      |      |     |     |       |       |     |     |              |              |                 |                 |
| ・             | 中央監視盤   |          |   |   |   |   |   |     |     |     |     |     |     |      |      |     |     |    |    |     |     |        |        |     |     |       |       |      |      |        |        |        |        |       |       |      |      |     |     |      |      |     |     |      |      |             |             |           |           |             |             |     |     |      |      |         |         |       |       |       |       |              |              |      |      |    |    |          |          |     |     |           |           |         |         |      |      |     |     |       |       |     |     |              |              |                 |                 |
| ・             | リモート盤   |          |   |   |   |   |   |     |     |     |     |     |     |      |      |     |     |    |    |     |     |        |        |     |     |       |       |      |      |        |        |        |        |       |       |      |      |     |     |      |      |     |     |      |      |             |             |           |           |             |             |     |     |      |      |         |         |       |       |       |       |              |              |      |      |    |    |          |          |     |     |           |           |         |         |      |      |     |     |       |       |     |     |              |              |                 |                 |
| ・             | 給排水衛生設備工事用機材  |          |   |   |   |   |   |     |     |     |     |     |     |      |      |     |     |    |    |     |     |        |        |     |     |       |       |      |      |        |        |        |        |       |       |      |      |     |     |      |      |     |     |      |      |             |             |           |           |             |             |     |     |      |      |         |         |       |       |       |       |              |              |      |      |    |    |          |          |     |     |           |           |         |         |      |      |     |     |       |       |     |     |              |              |                 |                 |
| ◎             | 衛生器具  |          |   |   |   |   |   |     |     |     |     |     |     |      |      |     |     |    |    |     |     |        |        |     |     |       |       |      |      |        |        |        |        |       |       |      |      |     |     |      |      |     |     |      |      |             |             |           |           |             |             |     |     |      |      |         |         |       |       |       |       |              |              |      |      |    |    |          |          |     |     |           |           |         |         |      |      |     |     |       |       |     |     |              |              |                 |                 |
| ◎             | 水栓  |          |   |   |   |   |   |     |     |     |     |     |     |      |      |     |     |    |    |     |     |        |        |     |     |       |       |      |      |        |        |        |        |       |       |      |      |     |     |      |      |     |     |      |      |             |             |           |           |             |             |     |     |      |      |         |         |       |       |       |       |              |              |      |      |    |    |          |          |     |     |           |           |         |         |      |      |     |     |       |       |     |     |              |              |                 |                 |
| ◎             | 組立てマンホール  |          |   |   |   |   |   |     |     |     |     |     |     |      |      |     |     |    |    |     |     |        |        |     |     |       |       |      |      |        |        |        |        |       |       |      |      |     |     |      |      |     |     |      |      |             |             |           |           |             |             |     |     |      |      |         |         |       |       |       |       |              |              |      |      |    |    |          |          |     |     |           |           |         |         |      |      |     |     |       |       |     |     |              |              |                 |                 |
| ・             | 浄化槽   |          |   |   |   |   |   |     |     |     |     |     |     |      |      |     |     |    |    |     |     |        |        |     |     |       |       |      |      |        |        |        |        |       |       |      |      |     |     |      |      |     |     |      |      |             |             |           |           |             |             |     |     |      |      |         |         |       |       |       |       |              |              |      |      |    |    |          |          |     |     |           |           |         |         |      |      |     |     |       |       |     |     |              |              |                 |                 |
| ・             | F R P 浄化槽   |          |   |   |   |   |   |     |     |     |     |     |     |      |      |     |     |    |    |     |     |        |        |     |     |       |       |      |      |        |        |        |        |       |       |      |      |     |     |      |      |     |     |      |      |             |             |           |           |             |             |     |     |      |      |         |         |       |       |       |       |              |              |      |      |    |    |          |          |     |     |           |           |         |         |      |      |     |     |       |       |     |     |              |              |                 |                 |
| ・             | 動力盤、制御盤   |          |   |   |   |   |   |     |     |     |     |     |     |      |      |     |     |    |    |     |     |        |        |     |     |       |       |      |      |        |        |        |        |       |       |      |      |     |     |      |      |     |     |      |      |             |             |           |           |             |             |     |     |      |      |         |         |       |       |       |       |              |              |      |      |    |    |          |          |     |     |           |           |         |         |      |      |     |     |       |       |     |     |              |              |                 |                 |
| ・             | プロワー  |          |   |   |   |   |   |     |     |     |     |     |     |      |      |     |     |    |    |     |     |        |        |     |     |       |       |      |      |        |        |        |        |       |       |      |      |     |     |      |      |     |     |      |      |             |             |           |           |             |             |     |     |      |      |         |         |       |       |       |       |              |              |      |      |    |    |          |          |     |     |           |           |         |         |      |      |     |     |       |       |     |     |              |              |                 |                 |
| ・             | さく井   |          |   |   |   |   |   |     |     |     |     |     |     |      |      |     |     |    |    |     |     |        |        |     |     |       |       |      |      |        |        |        |        |       |       |      |      |     |     |      |      |     |     |      |      |             |             |           |           |             |             |     |     |      |      |         |         |       |       |       |       |              |              |      |      |    |    |          |          |     |     |           |           |         |         |      |      |     |     |       |       |     |     |              |              |                 |                 |
| ・             | スクリーン   |          |   |   |   |   |   |     |     |     |     |     |     |      |      |     |     |    |    |     |     |        |        |     |     |       |       |      |      |        |        |        |        |       |       |      |      |     |     |      |      |     |     |      |      |             |             |           |           |             |             |     |     |      |      |         |         |       |       |       |       |              |              |      |      |    |    |          |          |     |     |           |           |         |         |      |      |     |     |       |       |     |     |              |              |                 |                 |
| ・             | その他   |          |   |   |   |   |   |     |     |     |     |     |     |      |      |     |     |    |    |     |     |        |        |     |     |       |       |      |      |        |        |        |        |       |       |      |      |     |     |      |      |     |     |      |      |             |             |           |           |             |             |     |     |      |      |         |         |       |       |       |       |              |              |      |      |    |    |          |          |     |     |           |           |         |         |      |      |     |     |       |       |     |     |              |              |                 |                 |
| ◎             | スリーブ (つば付鋼管)  |          |   |   |   |   |   |     |     |     |     |     |     |      |      |     |     |    |    |     |     |        |        |     |     |       |       |      |      |        |        |        |        |       |       |      |      |     |     |      |      |     |     |      |      |             |             |           |           |             |             |     |     |      |      |         |         |       |       |       |       |              |              |      |      |    |    |          |          |     |     |           |           |         |         |      |      |     |     |       |       |     |     |              |              |                 |                 |
| ・             | ◎ 印の付いたものを適用する。   |          |   |   |   |   |   |     |     |     |     |     |     |      |      |     |     |    |    |     |     |        |        |     |     |       |       |      |      |        |        |        |        |       |       |      |      |     |     |      |      |     |     |      |      |             |             |           |           |             |             |     |     |      |      |         |         |       |       |       |       |              |              |      |      |    |    |          |          |     |     |           |           |         |         |      |      |     |     |       |       |     |     |              |              |                 |                 |
| 14 ダクト保温の範囲   | 外気取入ダクト (OA) : 保温する<br>外気ダクト (EA) : 外壁から1m保温する<br>給気ダクト (SA) : 保温する<br>送気ダクト (RA) : 保温しない<br>排煙ダクト (SM) : 保温しない   | 2 屋内消火栓箱 | ※ 製造者標準仕様 ・ 標準図 (P - ) による。   | <p>別表 1</p> <table border="1"> <tr><th>名</th><th>称</th></tr> <tr><td>◎</td><td>配管類</td></tr> <tr><td>◎</td><td>給水管</td></tr> <tr><td>◎</td><td>排水管</td></tr> <tr><td>◎</td><td>冷温水管</td></tr> <tr><td>◎</td><td>冷煤管</td></tr> <tr><td>・</td><td>弁類</td></tr> <tr><td>◎</td><td>仕切弁</td></tr> <tr><td>・</td><td>バタフライ弁</td></tr> <tr><td>◎</td><td>逆止弁</td></tr> <tr><td>◎</td><td>緊急遮断弁</td></tr> <tr><td>・</td><td>ポンプ類</td></tr> <tr><td>◎</td><td>給水用ポンプ</td></tr> <tr><td>・</td><td>空調用ポンプ</td></tr> <tr><td>・</td><td>消火ポンプ</td></tr> <tr><td>・</td><td>タンク類</td></tr> <tr><td>◎</td><td>受水槽</td></tr> <tr><td>・</td><td>高架水槽</td></tr> <tr><td>・</td><td>貯湯槽</td></tr> <tr><td>・</td><td>膨張水槽</td></tr> <tr><td>・</td><td>空気調和設備工事用機材</td></tr> <tr><td>◎</td><td>パッケージエアコン</td></tr> <tr><td>・</td><td>空気調和機 (AHU)</td></tr> <tr><td>・</td><td>冷却塔</td></tr> <tr><td>・</td><td>ヘッダー</td></tr> <tr><td>・</td><td>自動制御機器類</td></tr> <tr><td>・</td><td>中央監視盤</td></tr> <tr><td>・</td><td>リモート盤</td></tr> <tr><td>・</td><td>給排水衛生設備工事用機材</td></tr> <tr><td>◎</td><td>衛生器具</td></tr> <tr><td>◎</td><td>水栓</td></tr> <tr><td>◎</td><td>組立てマンホール</td></tr> <tr><td>・</td><td>浄化槽</td></tr> <tr><td>・</td><td>F R P 浄化槽</td></tr> <tr><td>・</td><td>動力盤、制御盤</td></tr> <tr><td>・</td><td>プロワー</td></tr> <tr><td>・</td><td>さく井</td></tr> <tr><td>・</td><td>スクリーン</td></tr> <tr><td>・</td><td>その他</td></tr> <tr><td>◎</td><td>スリーブ (つば付鋼管)</td></tr> <tr><td>・</td><td>◎ 印の付いたものを適用する。</td></tr> </table> | 名   | 称   | ◎ | 配管類 | ◎   | 給水管 | ◎   | 排水管 | ◎   | 冷温水管 | ◎    | 冷煤管 | ・   | 弁類 | ◎  | 仕切弁 | ・   | バタフライ弁 | ◎      | 逆止弁 | ◎   | 緊急遮断弁 | ・     | ポンプ類 | ◎    | 給水用ポンプ | ・      | 空調用ポンプ | ・      | 消火ポンプ | ・     | タンク類 | ◎    | 受水槽 | ・   | 高架水槽 | ・    | 貯湯槽 | ・   | 膨張水槽 | ・    | 空気調和設備工事用機材 | ◎           | パッケージエアコン | ・         | 空気調和機 (AHU) | ・           | 冷却塔 | ・   | ヘッダー | ・    | 自動制御機器類 | ・       | 中央監視盤 | ・     | リモート盤 | ・     | 給排水衛生設備工事用機材 | ◎            | 衛生器具 | ◎    | 水栓 | ◎  | 組立てマンホール | ・        | 浄化槽 | ・   | F R P 浄化槽 | ・         | 動力盤、制御盤 | ・       | プロワー | ・    | さく井 | ・   | スクリーン | ・     | その他 | ◎   | スリーブ (つば付鋼管) | ・            | ◎ 印の付いたものを適用する。 |                 |
| 名             | 称   |          |   |   |   |   |   |     |     |     |     |     |     |      |      |     |     |    |    |     |     |        |        |     |     |       |       |      |      |        |        |        |        |       |       |      |      |     |     |      |      |     |     |      |      |             |             |           |           |             |             |     |     |      |      |         |         |       |       |       |       |              |              |      |      |    |    |          |          |     |     |           |           |         |         |      |      |     |     |       |       |     |     |              |              |                 |                 |
| ◎             | 配管類   |          |   |   |   |   |   |     |     |     |     |     |     |      |      |     |     |    |    |     |     |        |        |     |     |       |       |      |      |        |        |        |        |       |       |      |      |     |     |      |      |     |     |      |      |             |             |           |           |             |             |     |     |      |      |         |         |       |       |       |       |              |              |      |      |    |    |          |          |     |     |           |           |         |         |      |      |     |     |       |       |     |     |              |              |                 |                 |
| ◎             | 給水管   |          |   |   |   |   |   |     |     |     |     |     |     |      |      |     |     |    |    |     |     |        |        |     |     |       |       |      |      |        |        |        |        |       |       |      |      |     |     |      |      |     |     |      |      |             |             |           |           |             |             |     |     |      |      |         |         |       |       |       |       |              |              |      |      |    |    |          |          |     |     |           |           |         |         |      |      |     |     |       |       |     |     |              |              |                 |                 |
| ◎             | 排水管   |          |   |   |   |   |   |     |     |     |     |     |     |      |      |     |     |    |    |     |     |        |        |     |     |       |       |      |      |        |        |        |        |       |       |      |      |     |     |      |      |     |     |      |      |             |             |           |           |             |             |     |     |      |      |         |         |       |       |       |       |              |              |      |      |    |    |          |          |     |     |           |           |         |         |      |      |     |     |       |       |     |     |              |              |                 |                 |
| ◎             | 冷温水管  |          |   |   |   |   |   |     |     |     |     |     |     |      |      |     |     |    |    |     |     |        |        |     |     |       |       |      |      |        |        |        |        |       |       |      |      |     |     |      |      |     |     |      |      |             |             |           |           |             |             |     |     |      |      |         |         |       |       |       |       |              |              |      |      |    |    |          |          |     |     |           |           |         |         |      |      |     |     |       |       |     |     |              |              |                 |                 |
| ◎             | 冷煤管   |          |   |   |   |   |   |     |     |     |     |     |     |      |      |     |     |    |    |     |     |        |        |     |     |       |       |      |      |        |        |        |        |       |       |      |      |     |     |      |      |     |     |      |      |             |             |           |           |             |             |     |     |      |      |         |         |       |       |       |       |              |              |      |      |    |    |          |          |     |     |           |           |         |         |      |      |     |     |       |       |     |     |              |              |                 |                 |
| ・             | 弁類  |          |   |   |   |   |   |     |     |     |     |     |     |      |      |     |     |    |    |     |     |        |        |     |     |       |       |      |      |        |        |        |        |       |       |      |      |     |     |      |      |     |     |      |      |             |             |           |           |             |             |     |     |      |      |         |         |       |       |       |       |              |              |      |      |    |    |          |          |     |     |           |           |         |         |      |      |     |     |       |       |     |     |              |              |                 |                 |
| ◎             | 仕切弁   |          |   |   |   |   |   |     |     |     |     |     |     |      |      |     |     |    |    |     |     |        |        |     |     |       |       |      |      |        |        |        |        |       |       |      |      |     |     |      |      |     |     |      |      |             |             |           |           |             |             |     |     |      |      |         |         |       |       |       |       |              |              |      |      |    |    |          |          |     |     |           |           |         |         |      |      |     |     |       |       |     |     |              |              |                 |                 |
| ・             | バタフライ弁  |          |   |   |   |   |   |     |     |     |     |     |     |      |      |     |     |    |    |     |     |        |        |     |     |       |       |      |      |        |        |        |        |       |       |      |      |     |     |      |      |     |     |      |      |             |             |           |           |             |             |     |     |      |      |         |         |       |       |       |       |              |              |      |      |    |    |          |          |     |     |           |           |         |         |      |      |     |     |       |       |     |     |              |              |                 |                 |
| ◎             | 逆止弁   |          |   |   |   |   |   |     |     |     |     |     |     |      |      |     |     |    |    |     |     |        |        |     |     |       |       |      |      |        |        |        |        |       |       |      |      |     |     |      |      |     |     |      |      |             |             |           |           |             |             |     |     |      |      |         |         |       |       |       |       |              |              |      |      |    |    |          |          |     |     |           |           |         |         |      |      |     |     |       |       |     |     |              |              |                 |                 |
| ◎             | 緊急遮断弁   |          |   |   |   |   |   |     |     |     |     |     |     |      |      |     |     |    |    |     |     |        |        |     |     |       |       |      |      |        |        |        |        |       |       |      |      |     |     |      |      |     |     |      |      |             |             |           |           |             |             |     |     |      |      |         |         |       |       |       |       |              |              |      |      |    |    |          |          |     |     |           |           |         |         |      |      |     |     |       |       |     |     |              |              |                 |                 |
| ・             | ポンプ類  |          |   |   |   |   |   |     |     |     |     |     |     |      |      |     |     |    |    |     |     |        |        |     |     |       |       |      |      |        |        |        |        |       |       |      |      |     |     |      |      |     |     |      |      |             |             |           |           |             |             |     |     |      |      |         |         |       |       |       |       |              |              |      |      |    |    |          |          |     |     |           |           |         |         |      |      |     |     |       |       |     |     |              |              |                 |                 |
| ◎             | 給水用ポンプ  |          |   |   |   |   |   |     |     |     |     |     |     |      |      |     |     |    |    |     |     |        |        |     |     |       |       |      |      |        |        |        |        |       |       |      |      |     |     |      |      |     |     |      |      |             |             |           |           |             |             |     |     |      |      |         |         |       |       |       |       |              |              |      |      |    |    |          |          |     |     |           |           |         |         |      |      |     |     |       |       |     |     |              |              |                 |                 |
| ・             | 空調用ポンプ  |          |   |   |   |   |   |     |     |     |     |     |     |      |      |     |     |    |    |     |     |        |        |     |     |       |       |      |      |        |        |        |        |       |       |      |      |     |     |      |      |     |     |      |      |             |             |           |           |             |             |     |     |      |      |         |         |       |       |       |       |              |              |      |      |    |    |          |          |     |     |           |           |         |         |      |      |     |     |       |       |     |     |              |              |                 |                 |
| ・             | 消火ポンプ   |          |   |   |   |   |   |     |     |     |     |     |     |      |      |     |     |    |    |     |     |        |        |     |     |       |       |      |      |        |        |        |        |       |       |      |      |     |     |      |      |     |     |      |      |             |             |           |           |             |             |     |     |      |      |         |         |       |       |       |       |              |              |      |      |    |    |          |          |     |     |           |           |         |         |      |      |     |     |       |       |     |     |              |              |                 |                 |
| ・             | タンク類  |          |   |   |   |   |   |     |     |     |     |     |     |      |      |     |     |    |    |     |     |        |        |     |     |       |       |      |      |        |        |        |        |       |       |      |      |     |     |      |      |     |     |      |      |             |             |           |           |             |             |     |     |      |      |         |         |       |       |       |       |              |              |      |      |    |    |          |          |     |     |           |           |         |         |      |      |     |     |       |       |     |     |              |              |                 |                 |
| ◎             | 受水槽   |          |   |   |   |   |   |     |     |     |     |     |     |      |      |     |     |    |    |     |     |        |        |     |     |       |       |      |      |        |        |        |        |       |       |      |      |     |     |      |      |     |     |      |      |             |             |           |           |             |             |     |     |      |      |         |         |       |       |       |       |              |              |      |      |    |    |          |          |     |     |           |           |         |         |      |      |     |     |       |       |     |     |              |              |                 |                 |
| ・             | 高架水槽  |          |   |   |   |   |   |     |     |     |     |     |     |      |      |     |     |    |    |     |     |        |        |     |     |       |       |      |      |        |        |        |        |       |       |      |      |     |     |      |      |     |     |      |      |             |             |           |           |             |             |     |     |      |      |         |         |       |       |       |       |              |              |      |      |    |    |          |          |     |     |           |           |         |         |      |      |     |     |       |       |     |     |              |              |                 |                 |
| ・             | 貯湯槽   |          |   |   |   |   |   |     |     |     |     |     |     |      |      |     |     |    |    |     |     |        |        |     |     |       |       |      |      |        |        |        |        |       |       |      |      |     |     |      |      |     |     |      |      |             |             |           |           |             |             |     |     |      |      |         |         |       |       |       |       |              |              |      |      |    |    |          |          |     |     |           |           |         |         |      |      |     |     |       |       |     |     |              |              |                 |                 |
| ・             | 膨張水槽  |          |   |   |   |   |   |     |     |     |     |     |     |      |      |     |     |    |    |     |     |        |        |     |     |       |       |      |      |        |        |        |        |       |       |      |      |     |     |      |      |     |     |      |      |             |             |           |           |             |             |     |     |      |      |         |         |       |       |       |       |              |              |      |      |    |    |          |          |     |     |           |           |         |         |      |      |     |     |       |       |     |     |              |              |                 |                 |
| ・             | 空気調和設備工事用機材   |          |   |   |   |   |   |     |     |     |     |     |     |      |      |     |     |    |    |     |     |        |        |     |     |       |       |      |      |        |        |        |        |       |       |      |      |     |     |      |      |     |     |      |      |             |             |           |           |             |             |     |     |      |      |         |         |       |       |       |       |              |              |      |      |    |    |          |          |     |     |           |           |         |         |      |      |     |     |       |       |     |     |              |              |                 |                 |
| ◎             | パッケージエアコン   |          |   |   |   |   |   |     |     |     |     |     |     |      |      |     |     |    |    |     |     |        |        |     |     |       |       |      |      |        |        |        |        |       |       |      |      |     |     |      |      |     |     |      |      |             |             |           |           |             |             |     |     |      |      |         |         |       |       |       |       |              |              |      |      |    |    |          |          |     |     |           |           |         |         |      |      |     |     |       |       |     |     |              |              |                 |                 |
| ・             | 空気調和機 (AHU)   |          |   |   |   |   |   |     |     |     |     |     |     |      |      |     |     |    |    |     |     |        |        |     |     |       |       |      |      |        |        |        |        |       |       |      |      |     |     |      |      |     |     |      |      |             |             |           |           |             |             |     |     |      |      |         |         |       |       |       |       |              |              |      |      |    |    |          |          |     |     |           |           |         |         |      |      |     |     |       |       |     |     |              |              |                 |                 |
| ・             | 冷却塔   |          |   |   |   |   |   |     |     |     |     |     |     |      |      |     |     |    |    |     |     |        |        |     |     |       |       |      |      |        |        |        |        |       |       |      |      |     |     |      |      |     |     |      |      |             |             |           |           |             |             |     |     |      |      |         |         |       |       |       |       |              |              |      |      |    |    |          |          |     |     |           |           |         |         |      |      |     |     |       |       |     |     |              |              |                 |                 |
| ・             | ヘッダー  |          |   |   |   |   |   |     |     |     |     |     |     |      |      |     |     |    |    |     |     |        |        |     |     |       |       |      |      |        |        |        |        |       |       |      |      |     |     |      |      |     |     |      |      |             |             |           |           |             |             |     |     |      |      |         |         |       |       |       |       |              |              |      |      |    |    |          |          |     |     |           |           |         |         |      |      |     |     |       |       |     |     |              |              |                 |                 |
| ・             | 自動制御機器類   |          |   |   |   |   |   |     |     |     |     |     |     |      |      |     |     |    |    |     |     |        |        |     |     |       |       |      |      |        |        |        |        |       |       |      |      |     |     |      |      |     |     |      |      |             |             |           |           |             |             |     |     |      |      |         |         |       |       |       |       |              |              |      |      |    |    |          |          |     |     |           |           |         |         |      |      |     |     |       |       |     |     |              |              |                 |                 |
| ・             | 中央監視盤   |          |   |   |   |   |   |     |     |     |     |     |     |      |      |     |     |    |    |     |     |        |        |     |     |       |       |      |      |        |        |        |        |       |       |      |      |     |     |      |      |     |     |      |      |             |             |           |           |             |             |     |     |      |      |         |         |       |       |       |       |              |              |      |      |    |    |          |          |     |     |           |           |         |         |      |      |     |     |       |       |     |     |              |              |                 |                 |
| ・             | リモート盤   |          |   |   |   |   |   |     |     |     |     |     |     |      |      |     |     |    |    |     |     |        |        |     |     |       |       |      |      |        |        |        |        |       |       |      |      |     |     |      |      |     |     |      |      |             |             |           |           |             |             |     |     |      |      |         |         |       |       |       |       |              |              |      |      |    |    |          |          |     |     |           |           |         |         |      |      |     |     |       |       |     |     |              |              |                 |                 |
| ・             | 給排水衛生設備工事用機材  |          |   |   |   |   |   |     |     |     |     |     |     |      |      |     |     |    |    |     |     |        |        |     |     |       |       |      |      |        |        |        |        |       |       |      |      |     |     |      |      |     |     |      |      |             |             |           |           |             |             |     |     |      |      |         |         |       |       |       |       |              |              |      |      |    |    |          |          |     |     |           |           |         |         |      |      |     |     |       |       |     |     |              |              |                 |                 |
| ◎             | 衛生器具  |          |   |   |   |   |   |     |     |     |     |     |     |      |      |     |     |    |    |     |     |        |        |     |     |       |       |      |      |        |        |        |        |       |       |      |      |     |     |      |      |     |     |      |      |             |             |           |           |             |             |     |     |      |      |         |         |       |       |       |       |              |              |      |      |    |    |          |          |     |     |           |           |         |         |      |      |     |     |       |       |     |     |              |              |                 |                 |
| ◎             | 水栓  |          |   |   |   |   |   |     |     |     |     |     |     |      |      |     |     |    |    |     |     |        |        |     |     |       |       |      |      |        |        |        |        |       |       |      |      |     |     |      |      |     |     |      |      |             |             |           |           |             |             |     |     |      |      |         |         |       |       |       |       |              |              |      |      |    |    |          |          |     |     |           |           |         |         |      |      |     |     |       |       |     |     |              |              |                 |                 |
| ◎             | 組立てマンホール  |          |   |   |   |   |   |     |     |     |     |     |     |      |      |     |     |    |    |     |     |        |        |     |     |       |       |      |      |        |        |        |        |       |       |      |      |     |     |      |      |     |     |      |      |             |             |           |           |             |             |     |     |      |      |         |         |       |       |       |       |              |              |      |      |    |    |          |          |     |     |           |           |         |         |      |      |     |     |       |       |     |     |              |              |                 |                 |
| ・             | 浄化槽   |          |   |   |   |   |   |     |     |     |     |     |     |      |      |     |     |    |    |     |     |        |        |     |     |       |       |      |      |        |        |        |        |       |       |      |      |     |     |      |      |     |     |      |      |             |             |           |           |             |             |     |     |      |      |         |         |       |       |       |       |              |              |      |      |    |    |          |          |     |     |           |           |         |         |      |      |     |     |       |       |     |     |              |              |                 |                 |
| ・             | F R P 浄化槽   |          |   |   |   |   |   |     |     |     |     |     |     |      |      |     |     |    |    |     |     |        |        |     |     |       |       |      |      |        |        |        |        |       |       |      |      |     |     |      |      |     |     |      |      |             |             |           |           |             |             |     |     |      |      |         |         |       |       |       |       |              |              |      |      |    |    |          |          |     |     |           |           |         |         |      |      |     |     |       |       |     |     |              |              |                 |                 |
| ・             | 動力盤、制御盤   |          |   |   |   |   |   |     |     |     |     |     |     |      |      |     |     |    |    |     |     |        |        |     |     |       |       |      |      |        |        |        |        |       |       |      |      |     |     |      |      |     |     |      |      |             |             |           |           |             |             |     |     |      |      |         |         |       |       |       |       |              |              |      |      |    |    |          |          |     |     |           |           |         |         |      |      |     |     |       |       |     |     |              |              |                 |                 |
| ・             | プロワー  |          |   |   |   |   |   |     |     |     |     |     |     |      |      |     |     |    |    |     |     |        |        |     |     |       |       |      |      |        |        |        |        |       |       |      |      |     |     |      |      |     |     |      |      |             |             |           |           |             |             |     |     |      |      |         |         |       |       |       |       |              |              |      |      |    |    |          |          |     |     |           |           |         |         |      |      |     |     |       |       |     |     |              |              |                 |                 |
| ・             | さく井   |          |   |   |   |   |   |     |     |     |     |     |     |      |      |     |     |    |    |     |     |        |        |     |     |       |       |      |      |        |        |        |        |       |       |      |      |     |     |      |      |     |     |      |      |             |             |           |           |             |             |     |     |      |      |         |         |       |       |       |       |              |              |      |      |    |    |          |          |     |     |           |           |         |         |      |      |     |     |       |       |     |     |              |              |                 |                 |
| ・             | スクリーン   |          |   |   |   |   |   |     |     |     |     |     |     |      |      |     |     |    |    |     |     |        |        |     |     |       |       |      |      |        |        |        |        |       |       |      |      |     |     |      |      |     |     |      |      |             |             |           |           |             |             |     |     |      |      |         |         |       |       |       |       |              |              |      |      |    |    |          |          |     |     |           |           |         |         |      |      |     |     |       |       |     |     |              |              |                 |                 |
| ・             | その他   |          |   |   |   |   |   |     |     |     |     |     |     |      |      |     |     |    |    |     |     |        |        |     |     |       |       |      |      |        |        |        |        |       |       |      |      |     |     |      |      |     |     |      |      |             |             |           |           |             |             |     |     |      |      |         |         |       |       |       |       |              |              |      |      |    |    |          |          |     |     |           |           |         |         |      |      |     |     |       |       |     |     |              |              |                 |                 |
| ◎             | スリーブ (つば付鋼管)  |          |   |   |   |   |   |     |     |     |     |     |     |      |      |     |     |    |    |     |     |        |        |     |     |       |       |      |      |        |        |        |        |       |       |      |      |     |     |      |      |     |     |      |      |             |             |           |           |             |             |     |     |      |      |         |         |       |       |       |       |              |              |      |      |    |    |          |          |     |     |           |           |         |         |      |      |     |     |       |       |     |     |              |              |                 |                 |
| ・             | ◎ 印の付いたものを適用する。   |          |   |   |   |   |   |     |     |     |     |     |     |      |      |     |     |    |    |     |     |        |        |     |     |       |       |      |      |        |        |        |        |       |       |      |      |     |     |      |      |     |     |      |      |             |             |           |           |             |             |     |     |      |      |         |         |       |       |       |       |              |              |      |      |    |    |          |          |     |     |           |           |         |         |      |      |     |     |       |       |     |     |              |              |                 |                 |
| 排煙設備          | 1 ダクト ※ 亜鉛鉄板 ・ 普通鋼板 (板厚 ※ 1.6 mm ・ mm)<br>2 排煙口の形式 ・ 天井取付 ( ・ スリット形 ・ パネル形 )<br>・ 壁取付 ( ・ スリット形 )<br>3 排煙口開放装置 ・ 電気式 ( 遠隔復帰 ・ 要 ・ 不要 )<br>・ ワイヤ式<br>4 排煙風量測定 建築設備定期検査業務基準書2016年版 (一財)日本建築設備<br>・ 昇降機センター) の排煙風量の検査方法に準ずる。   | ガス設備     | 1 ガスの種類 ・ 都市ガス Kcal/nm3<br>◎ 液化石油ガス 24,000Kcal/nm3<br>2 配管材料 屋内一般 ※ 配管用炭素鋼鋼管 (白)<br>◎ 図示による<br>地中埋設 ※ ポリエチレン被覆鋼管 (PLP・PLS)<br>◎ 図示による<br>3 ガスメーター ※ 貸与品 ・ 本工事<br>4 ガス漏れ警報機 外部出力端子 ( ※ 有 ・ 無 )<br>5 緊急遮断弁 ◎ 設ける ・ 設けない<br>6 その他 ガスボンベ転倒防止の鎖は本工事とする。  | <p>別表 1</p> <table border="1"> <tr><th>名</th><th>称</th></tr> <tr><td>◎</td><td>配管類</td></tr> <tr><td>◎</td><td>給水管</td></tr> <tr><td>◎</td><td>排水管</td></tr> <tr><td>◎</td><td>冷温水管</td></tr> <tr><td>◎</td><td>冷煤管</td></tr> <tr><td>・</td><td>弁類</td></tr> <tr><td>◎</td><td>仕切弁</td></tr> <tr><td>・</td><td>バタフライ弁</td></tr> <tr><td>◎</td><td>逆止弁</td></tr> <tr><td>◎</td><td>緊急遮断弁</td></tr> <tr><td>・</td><td>ポンプ類</td></tr> <tr><td>◎</td><td>給水用ポンプ</td></tr> <tr><td>・</td><td>空調用ポンプ</td></tr> <tr><td>・</td><td>消火ポンプ</td></tr> <tr><td>・</td><td>タンク類</td></tr> <tr><td>◎</td><td>受水槽</td></tr> <tr><td>・</td><td>高架水槽</td></tr> <tr><td>・</td><td>貯湯槽</td></tr> <tr><td>・</td><td>膨張水槽</td></tr> <tr><td>・</td><td>空気調和設備工事用機材</td></tr> <tr><td>◎</td><td>パッケージエアコン</td></tr> <tr><td>・</td><td>空気調和機 (AHU)</td></tr> <tr><td>・</td><td>冷却塔</td></tr> <tr><td>・</td><td>ヘッダー</td></tr> <tr><td>・</td><td>自動制御機器類</td></tr> <tr><td>・</td><td>中央監視盤</td></tr> <tr><td>・</td><td>リモート盤</td></tr> <tr><td>・</td><td>給排水衛生設備工事用機材</td></tr> <tr><td>◎</td><td>衛生器具</td></tr> <tr><td>◎</td><td>水栓</td></tr> <tr><td>◎</td><td>組立てマンホール</td></tr> <tr><td>・</td><td>浄化槽</td></tr> <tr><td>・</td><td>F R P 浄化槽</td></tr> <tr><td>・</td><td>動力盤、制御盤</td></tr> <tr><td>・</td><td>プロワー</td></tr> <tr><td>・</td><td>さく井</td></tr> <tr><td>・</td><td>スクリーン</td></tr> <tr><td>・</td><td>その他</td></tr> <tr><td>◎</td><td>スリーブ (つば付鋼管)</td></tr> <tr><td>・</td><td>◎ 印の付いたものを適用する。</td></tr> </table> | 名   | 称   | ◎ | 配管類 | ◎   | 給水管 | ◎   | 排水管 | ◎   | 冷温水管 | ◎    | 冷煤管 | ・   | 弁類 | ◎  | 仕切弁 | ・   | バタフライ弁 | ◎      | 逆止弁 | ◎   | 緊急遮断弁 | ・     | ポンプ類 | ◎    | 給水用ポンプ | ・      | 空調用ポンプ | ・      | 消火ポンプ | ・     | タンク類 | ◎    | 受水槽 | ・   | 高架水槽 | ・    | 貯湯槽 | ・   | 膨張水槽 | ・    | 空気調和設備工事用機材 | ◎           | パッケージエアコン | ・         | 空気調和機 (AHU) | ・           | 冷却塔 | ・   | ヘッダー | ・    | 自動制御機器類 | ・       | 中央監視盤 | ・     | リモート盤 | ・     | 給排水衛生設備工事用機材 | ◎            | 衛生器具 | ◎    | 水栓 | ◎  | 組立てマンホール | ・        | 浄化槽 | ・   | F R P 浄化槽 | ・         | 動力盤、制御盤 | ・       | プロワー | ・    | さく井 | ・   | スクリーン | ・     | その他 | ◎   | スリーブ (つば付鋼管) | ・            | ◎ 印の付いたものを適用する。 |                 |
| 名             | 称   |          |   |   |   |   |   |     |     |     |     |     |     |      |      |     |     |    |    |     |     |        |        |     |     |       |       |      |      |        |        |        |        |       |       |      |      |     |     |      |      |     |     |      |      |             |             |           |           |             |             |     |     |      |      |         |         |       |       |       |       |              |              |      |      |    |    |          |          |     |     |           |           |         |         |      |      |     |     |       |       |     |     |              |              |                 |                 |
| ◎             | 配管類   |          |   |   |   |   |   |     |     |     |     |     |     |      |      |     |     |    |    |     |     |        |        |     |     |       |       |      |      |        |        |        |        |       |       |      |      |     |     |      |      |     |     |      |      |             |             |           |           |             |             |     |     |      |      |         |         |       |       |       |       |              |              |      |      |    |    |          |          |     |     |           |           |         |         |      |      |     |     |       |       |     |     |              |              |                 |                 |
| ◎             | 給水管   |          |   |   |   |   |   |     |     |     |     |     |     |      |      |     |     |    |    |     |     |        |        |     |     |       |       |      |      |        |        |        |        |       |       |      |      |     |     |      |      |     |     |      |      |             |             |           |           |             |             |     |     |      |      |         |         |       |       |       |       |              |              |      |      |    |    |          |          |     |     |           |           |         |         |      |      |     |     |       |       |     |     |              |              |                 |                 |
| ◎             | 排水管   |          |   |   |   |   |   |     |     |     |     |     |     |      |      |     |     |    |    |     |     |        |        |     |     |       |       |      |      |        |        |        |        |       |       |      |      |     |     |      |      |     |     |      |      |             |             |           |           |             |             |     |     |      |      |         |         |       |       |       |       |              |              |      |      |    |    |          |          |     |     |           |           |         |         |      |      |     |     |       |       |     |     |              |              |                 |                 |
| ◎             | 冷温水管  |          |   |   |   |   |   |     |     |     |     |     |     |      |      |     |     |    |    |     |     |        |        |     |     |       |       |      |      |        |        |        |        |       |       |      |      |     |     |      |      |     |     |      |      |             |             |           |           |             |             |     |     |      |      |         |         |       |       |       |       |              |              |      |      |    |    |          |          |     |     |           |           |         |         |      |      |     |     |       |       |     |     |              |              |                 |                 |
| ◎             | 冷煤管   |          |   |   |   |   |   |     |     |     |     |     |     |      |      |     |     |    |    |     |     |        |        |     |     |       |       |      |      |        |        |        |        |       |       |      |      |     |     |      |      |     |     |      |      |             |             |           |           |             |             |     |     |      |      |         |         |       |       |       |       |              |              |      |      |    |    |          |          |     |     |           |           |         |         |      |      |     |     |       |       |     |     |              |              |                 |                 |
| ・             | 弁類  |          |   |   |   |   |   |     |     |     |     |     |     |      |      |     |     |    |    |     |     |        |        |     |     |       |       |      |      |        |        |        |        |       |       |      |      |     |     |      |      |     |     |      |      |             |             |           |           |             |             |     |     |      |      |         |         |       |       |       |       |              |              |      |      |    |    |          |          |     |     |           |           |         |         |      |      |     |     |       |       |     |     |              |              |                 |                 |
| ◎             | 仕切弁   |          |   |   |   |   |   |     |     |     |     |     |     |      |      |     |     |    |    |     |     |        |        |     |     |       |       |      |      |        |        |        |        |       |       |      |      |     |     |      |      |     |     |      |      |             |             |           |           |             |             |     |     |      |      |         |         |       |       |       |       |              |              |      |      |    |    |          |          |     |     |           |           |         |         |      |      |     |     |       |       |     |     |              |              |                 |                 |
| ・             | バタフライ弁  |          |   |   |   |   |   |     |     |     |     |     |     |      |      |     |     |    |    |     |     |        |        |     |     |       |       |      |      |        |        |        |        |       |       |      |      |     |     |      |      |     |     |      |      |             |             |           |           |             |             |     |     |      |      |         |         |       |       |       |       |              |              |      |      |    |    |          |          |     |     |           |           |         |         |      |      |     |     |       |       |     |     |              |              |                 |                 |
| ◎             | 逆止弁   |          |   |   |   |   |   |     |     |     |     |     |     |      |      |     |     |    |    |     |     |        |        |     |     |       |       |      |      |        |        |        |        |       |       |      |      |     |     |      |      |     |     |      |      |             |             |           |           |             |             |     |     |      |      |         |         |       |       |       |       |              |              |      |      |    |    |          |          |     |     |           |           |         |         |      |      |     |     |       |       |     |     |              |              |                 |                 |
| ◎             | 緊急遮断弁   |          |   |   |   |   |   |     |     |     |     |     |     |      |      |     |     |    |    |     |     |        |        |     |     |       |       |      |      |        |        |        |        |       |       |      |      |     |     |      |      |     |     |      |      |             |             |           |           |             |             |     |     |      |      |         |         |       |       |       |       |              |              |      |      |    |    |          |          |     |     |           |           |         |         |      |      |     |     |       |       |     |     |              |              |                 |                 |
| ・             | ポンプ類  |          |   |   |   |   |   |     |     |     |     |     |     |      |      |     |     |    |    |     |     |        |        |     |     |       |       |      |      |        |        |        |        |       |       |      |      |     |     |      |      |     |     |      |      |             |             |           |           |             |             |     |     |      |      |         |         |       |       |       |       |              |              |      |      |    |    |          |          |     |     |           |           |         |         |      |      |     |     |       |       |     |     |              |              |                 |                 |
| ◎             | 給水用ポンプ  |          |   |   |   |   |   |     |     |     |     |     |     |      |      |     |     |    |    |     |     |        |        |     |     |       |       |      |      |        |        |        |        |       |       |      |      |     |     |      |      |     |     |      |      |             |             |           |           |             |             |     |     |      |      |         |         |       |       |       |       |              |              |      |      |    |    |          |          |     |     |           |           |         |         |      |      |     |     |       |       |     |     |              |              |                 |                 |
| ・             | 空調用ポンプ  |          |   |   |   |   |   |     |     |     |     |     |     |      |      |     |     |    |    |     |     |        |        |     |     |       |       |      |      |        |        |        |        |       |       |      |      |     |     |      |      |     |     |      |      |             |             |           |           |             |             |     |     |      |      |         |         |       |       |       |       |              |              |      |      |    |    |          |          |     |     |           |           |         |         |      |      |     |     |       |       |     |     |              |              |                 |                 |
| ・             | 消火ポンプ   |          |   |   |   |   |   |     |     |     |     |     |     |      |      |     |     |    |    |     |     |        |        |     |     |       |       |      |      |        |        |        |        |       |       |      |      |     |     |      |      |     |     |      |      |             |             |           |           |             |             |     |     |      |      |         |         |       |       |       |       |              |              |      |      |    |    |          |          |     |     |           |           |         |         |      |      |     |     |       |       |     |     |              |              |                 |                 |
| ・             | タンク類  |          |   |   |   |   |   |     |     |     |     |     |     |      |      |     |     |    |    |     |     |        |        |     |     |       |       |      |      |        |        |        |        |       |       |      |      |     |     |      |      |     |     |      |      |             |             |           |           |             |             |     |     |      |      |         |         |       |       |       |       |              |              |      |      |    |    |          |          |     |     |           |           |         |         |      |      |     |     |       |       |     |     |              |              |                 |                 |
| ◎             | 受水槽   |          |   |   |   |   |   |     |     |     |     |     |     |      |      |     |     |    |    |     |     |        |        |     |     |       |       |      |      |        |        |        |        |       |       |      |      |     |     |      |      |     |     |      |      |             |             |           |           |             |             |     |     |      |      |         |         |       |       |       |       |              |              |      |      |    |    |          |          |     |     |           |           |         |         |      |      |     |     |       |       |     |     |              |              |                 |                 |
| ・             | 高架水槽  |          |   |   |   |   |   |     |     |     |     |     |     |      |      |     |     |    |    |     |     |        |        |     |     |       |       |      |      |        |        |        |        |       |       |      |      |     |     |      |      |     |     |      |      |             |             |           |           |             |             |     |     |      |      |         |         |       |       |       |       |              |              |      |      |    |    |          |          |     |     |           |           |         |         |      |      |     |     |       |       |     |     |              |              |                 |                 |
| ・             | 貯湯槽   |          |   |   |   |   |   |     |     |     |     |     |     |      |      |     |     |    |    |     |     |        |        |     |     |       |       |      |      |        |        |        |        |       |       |      |      |     |     |      |      |     |     |      |      |             |             |           |           |             |             |     |     |      |      |         |         |       |       |       |       |              |              |      |      |    |    |          |          |     |     |           |           |         |         |      |      |     |     |       |       |     |     |              |              |                 |                 |
| ・             | 膨張水槽  |          |   |   |   |   |   |     |     |     |     |     |     |      |      |     |     |    |    |     |     |        |        |     |     |       |       |      |      |        |        |        |        |       |       |      |      |     |     |      |      |     |     |      |      |             |             |           |           |             |             |     |     |      |      |         |         |       |       |       |       |              |              |      |      |    |    |          |          |     |     |           |           |         |         |      |      |     |     |       |       |     |     |              |              |                 |                 |
| ・             | 空気調和設備工事用機材   |          |   |   |   |   |   |     |     |     |     |     |     |      |      |     |     |    |    |     |     |        |        |     |     |       |       |      |      |        |        |        |        |       |       |      |      |     |     |      |      |     |     |      |      |             |             |           |           |             |             |     |     |      |      |         |         |       |       |       |       |              |              |      |      |    |    |          |          |     |     |           |           |         |         |      |      |     |     |       |       |     |     |              |              |                 |                 |
| ◎             | パッケージエアコン   |          |   |   |   |   |   |     |     |     |     |     |     |      |      |     |     |    |    |     |     |        |        |     |     |       |       |      |      |        |        |        |        |       |       |      |      |     |     |      |      |     |     |      |      |             |             |           |           |             |             |     |     |      |      |         |         |       |       |       |       |              |              |      |      |    |    |          |          |     |     |           |           |         |         |      |      |     |     |       |       |     |     |              |              |                 |                 |
| ・             | 空気調和機 (AHU)   |          |   |   |   |   |   |     |     |     |     |     |     |      |      |     |     |    |    |     |     |        |        |     |     |       |       |      |      |        |        |        |        |       |       |      |      |     |     |      |      |     |     |      |      |             |             |           |           |             |             |     |     |      |      |         |         |       |       |       |       |              |              |      |      |    |    |          |          |     |     |           |           |         |         |      |      |     |     |       |       |     |     |              |              |                 |                 |
| ・             | 冷却塔   |          |   |   |   |   |   |     |     |     |     |     |     |      |      |     |     |    |    |     |     |        |        |     |     |       |       |      |      |        |        |        |        |       |       |      |      |     |     |      |      |     |     |      |      |             |             |           |           |             |             |     |     |      |      |         |         |       |       |       |       |              |              |      |      |    |    |          |          |     |     |           |           |         |         |      |      |     |     |       |       |     |     |              |              |                 |                 |
| ・             | ヘッダー  |          |   |   |   |   |   |     |     |     |     |     |     |      |      |     |     |    |    |     |     |        |        |     |     |       |       |      |      |        |        |        |        |       |       |      |      |     |     |      |      |     |     |      |      |             |             |           |           |             |             |     |     |      |      |         |         |       |       |       |       |              |              |      |      |    |    |          |          |     |     |           |           |         |         |      |      |     |     |       |       |     |     |              |              |                 |                 |
| ・             | 自動制御機器類   |          |   |   |   |   |   |     |     |     |     |     |     |      |      |     |     |    |    |     |     |        |        |     |     |       |       |      |      |        |        |        |        |       |       |      |      |     |     |      |      |     |     |      |      |             |             |           |           |             |             |     |     |      |      |         |         |       |       |       |       |              |              |      |      |    |    |          |          |     |     |           |           |         |         |      |      |     |     |       |       |     |     |              |              |                 |                 |
| ・             | 中央監視盤   |          |   |   |   |   |   |     |     |     |     |     |     |      |      |     |     |    |    |     |     |        |        |     |     |       |       |      |      |        |        |        |        |       |       |      |      |     |     |      |      |     |     |      |      |             |             |           |           |             |             |     |     |      |      |         |         |       |       |       |       |              |              |      |      |    |    |          |          |     |     |           |           |         |         |      |      |     |     |       |       |     |     |              |              |                 |                 |
| ・             | リモート盤   |          |   |   |   |   |   |     |     |     |     |     |     |      |      |     |     |    |    |     |     |        |        |     |     |       |       |      |      |        |        |        |        |       |       |      |      |     |     |      |      |     |     |      |      |             |             |           |           |             |             |     |     |      |      |         |         |       |       |       |       |              |              |      |      |    |    |          |          |     |     |           |           |         |         |      |      |     |     |       |       |     |     |              |              |                 |                 |
| ・             | 給排水衛生設備工事用機材  |          |   |   |   |   |   |     |     |     |     |     |     |      |      |     |     |    |    |     |     |        |        |     |     |       |       |      |      |        |        |        |        |       |       |      |      |     |     |      |      |     |     |      |      |             |             |           |           |             |             |     |     |      |      |         |         |       |       |       |       |              |              |      |      |    |    |          |          |     |     |           |           |         |         |      |      |     |     |       |       |     |     |              |              |                 |                 |
| ◎             | 衛生器具  |          |   |   |   |   |   |     |     |     |     |     |     |      |      |     |     |    |    |     |     |        |        |     |     |       |       |      |      |        |        |        |        |       |       |      |      |     |     |      |      |     |     |      |      |             |             |           |           |             |             |     |     |      |      |         |         |       |       |       |       |              |              |      |      |    |    |          |          |     |     |           |           |         |         |      |      |     |     |       |       |     |     |              |              |                 |                 |
| ◎             | 水栓  |          |   |   |   |   |   |     |     |     |     |     |     |      |      |     |     |    |    |     |     |        |        |     |     |       |       |      |      |        |        |        |        |       |       |      |      |     |     |      |      |     |     |      |      |             |             |           |           |             |             |     |     |      |      |         |         |       |       |       |       |              |              |      |      |    |    |          |          |     |     |           |           |         |         |      |      |     |     |       |       |     |     |              |              |                 |                 |
| ◎             | 組立てマンホール  |          |   |   |   |   |   |     |     |     |     |     |     |      |      |     |     |    |    |     |     |        |        |     |     |       |       |      |      |        |        |        |        |       |       |      |      |     |     |      |      |     |     |      |      |             |             |           |           |             |             |     |     |      |      |         |         |       |       |       |       |              |              |      |      |    |    |          |          |     |     |           |           |         |         |      |      |     |     |       |       |     |     |              |              |                 |                 |
| ・             | 浄化槽   |          |   |   |   |   |   |     |     |     |     |     |     |      |      |     |     |    |    |     |     |        |        |     |     |       |       |      |      |        |        |        |        |       |       |      |      |     |     |      |      |     |     |      |      |             |             |           |           |             |             |     |     |      |      |         |         |       |       |       |       |              |              |      |      |    |    |          |          |     |     |           |           |         |         |      |      |     |     |       |       |     |     |              |              |                 |                 |
| ・             | F R P 浄化槽   |          |   |   |   |   |   |     |     |     |     |     |     |      |      |     |     |    |    |     |     |        |        |     |     |       |       |      |      |        |        |        |        |       |       |      |      |     |     |      |      |     |     |      |      |             |             |           |           |             |             |     |     |      |      |         |         |       |       |       |       |              |              |      |      |    |    |          |          |     |     |           |           |         |         |      |      |     |     |       |       |     |     |              |              |                 |                 |
| ・             | 動力盤、制御盤   |          |   |   |   |   |   |     |     |     |     |     |     |      |      |     |     |    |    |     |     |        |        |     |     |       |       |      |      |        |        |        |        |       |       |      |      |     |     |      |      |     |     |      |      |             |             |           |           |             |             |     |     |      |      |         |         |       |       |       |       |              |              |      |      |    |    |          |          |     |     |           |           |         |         |      |      |     |     |       |       |     |     |              |              |                 |                 |
| ・             | プロワー  |          |   |   |   |   |   |     |     |     |     |     |     |      |      |     |     |    |    |     |     |        |        |     |     |       |       |      |      |        |        |        |        |       |       |      |      |     |     |      |      |     |     |      |      |             |             |           |           |             |             |     |     |      |      |         |         |       |       |       |       |              |              |      |      |    |    |          |          |     |     |           |           |         |         |      |      |     |     |       |       |     |     |              |              |                 |                 |
| ・             | さく井   |          |   |   |   |   |   |     |     |     |     |     |     |      |      |     |     |    |    |     |     |        |        |     |     |       |       |      |      |        |        |        |        |       |       |      |      |     |     |      |      |     |     |      |      |             |             |           |           |             |             |     |     |      |      |         |         |       |       |       |       |              |              |      |      |    |    |          |          |     |     |           |           |         |         |      |      |     |     |       |       |     |     |              |              |                 |                 |
| ・             | スクリーン   |          |   |   |   |   |   |     |     |     |     |     |     |      |      |     |     |    |    |     |     |        |        |     |     |       |       |      |      |        |        |        |        |       |       |      |      |     |     |      |      |     |     |      |      |             |             |           |           |             |             |     |     |      |      |         |         |       |       |       |       |              |              |      |      |    |    |          |          |     |     |           |           |         |         |      |      |     |     |       |       |     |     |              |              |                 |                 |
| ・             | その他   |          |   |   |   |   |   |     |     |     |     |     |     |      |      |     |     |    |    |     |     |        |        |     |     |       |       |      |      |        |        |        |        |       |       |      |      |     |     |      |      |     |     |      |      |             |             |           |           |             |             |     |     |      |      |         |         |       |       |       |       |              |              |      |      |    |    |          |          |     |     |           |           |         |         |      |      |     |     |       |       |     |     |              |              |                 |                 |
| ◎             | スリーブ (つば付鋼管)  |          |   |   |   |   |   |     |     |     |     |     |     |      |      |     |     |    |    |     |     |        |        |     |     |       |       |      |      |        |        |        |        |       |       |      |      |     |     |      |      |     |     |      |      |             |             |           |           |             |             |     |     |      |      |         |         |       |       |       |       |              |              |      |      |    |    |          |          |     |     |           |           |         |         |      |      |     |     |       |       |     |     |              |              |                 |                 |
| ・             | ◎ 印の付いたものを適用する。   |          |   |   |   |   |   |     |     |     |     |     |     |      |      |     |     |    |    |     |     |        |        |     |     |       |       |      |      |        |        |        |        |       |       |      |      |     |     |      |      |     |     |      |      |             |             |           |           |             |             |     |     |      |      |         |         |       |       |       |       |              |              |      |      |    |    |          |          |     |     |           |           |         |         |      |      |     |     |       |       |     |     |              |              |                 |                 |
| 衛生器具設備        | 1 掃除流し 排水口形式 ※ 目皿 ・ 鎖付き共栓<br>2 洗浄水量 改修工事における大便器の洗浄水量の調整<br>調整を ( ※ 行う ・ 行わない )<br>大便器の洗浄水量の調整は次のとおりとする。<br>新設の場合 : 6.5リットル、既存利用の場合 : 便器の仕様に合わせて   | 浄化槽設備    | 1 処理方式 合併処理 ・ 建築基準法施行令第35条の認定品による<br>・ 建設省告示第1292号による。第 ( ) ( ) 方式)<br>2 処理能力 処理対象人員 人<br>処理水量 m3/日<br>3 本体構造 ・ コンクリート製 ・ F R P 製<br>4 放流水質 BOD ppm 以下<br>5 配管材料 ・ 一般配管用ステンレス鋼管 ( )<br>・ 耐熱性硬質塩化ビニル管 ( )<br>・ 配管用炭素鋼鋼管 (白) ( )<br>・<br>6 土留め工法 ・  | <p>別表 1</p> <table border="1"> <tr><th>名</th><th>称</th></tr> <tr><td>◎</td><td>配管類</td></tr> <tr><td>◎</td><td>給水管</td></tr> <tr><td>◎</td><td>排水管</td></tr> <tr><td>◎</td><td>冷温水管</td></tr> <tr><td>◎</td><td>冷煤管</td></tr> <tr><td>・</td><td>弁類</td></tr> <tr><td>◎</td><td>仕切弁</td></tr> <tr><td>・</td><td>バタフライ弁</td></tr> <tr><td>◎</td><td>逆止弁</td></tr> <tr><td>◎</td><td>緊急遮断弁</td></tr> <tr><td>・</td><td>ポンプ類</td></tr> <tr><td>◎</td><td>給水用ポンプ</td></tr> <tr><td>・</td><td>空調用ポンプ</td></tr> <tr><td>・</td><td>消火ポンプ</td></tr> <tr><td>・</td><td>タンク類</td></tr> <tr><td>◎</td><td>受水槽</td></tr> <tr><td>・</td><td>高架水槽</td></tr> <tr><td>・</td><td>貯湯槽</td></tr> <tr><td>・</td><td>膨張水槽</td></tr> <tr><td>・</td><td>空気調和設備工事用機材</td></tr> <tr><td>◎</td><td>パッケージエアコン</td></tr> <tr><td>・</td><td>空気調和機 (AHU)</td></tr> <tr><td>・</td><td>冷却塔</td></tr> <tr><td>・</td><td>ヘッダー</td></tr> <tr><td>・</td><td>自動制御機器類</td></tr> <tr><td>・</td><td>中央監視盤</td></tr> <tr><td>・</td><td>リモート盤</td></tr> <tr><td>・</td><td>給排水衛生設備工事用機材</td></tr> <tr><td>◎</td><td>衛生器具</td></tr> <tr><td>◎</td><td>水栓</td></tr> <tr><td>◎</td><td>組立てマンホール</td></tr> <tr><td>・</td><td>浄化槽</td></tr> <tr><td>・</td><td>F R P 浄化槽</td></tr> <tr><td>・</td><td>動力盤、制御盤</td></tr> <tr><td>・</td><td>プロワー</td></tr> <tr><td>・</td><td>さく井</td></tr> <tr><td>・</td><td>スクリーン</td></tr> <tr><td>・</td><td>その他</td></tr> <tr><td>◎</td><td>スリーブ (つば付鋼管)</td></tr> <tr><td>・</td><td>◎ 印の付いたものを適用する。</td></tr> </table> | 名   | 称   | ◎ | 配管類 | ◎   | 給水管 | ◎   | 排水管 | ◎   | 冷温水管 | ◎    | 冷煤管 | ・   | 弁類 | ◎  | 仕切弁 | ・   | バタフライ弁 | ◎      | 逆止弁 | ◎   | 緊急遮断弁 | ・     | ポンプ類 | ◎    | 給水用ポンプ | ・      | 空調用ポンプ | ・      | 消火ポンプ | ・     | タンク類 | ◎    | 受水槽 | ・   | 高架水槽 | ・    | 貯湯槽 | ・   | 膨張水槽 | ・    | 空気調和設備工事用機材 | ◎           | パッケージエアコン | ・         | 空気調和機 (AHU) | ・           | 冷却塔 | ・   | ヘッダー | ・    | 自動制御機器類 | ・       | 中央監視盤 | ・     | リモート盤 | ・     | 給排水衛生設備工事用機材 | ◎            | 衛生器具 | ◎    | 水栓 | ◎  | 組立てマンホール | ・        | 浄化槽 | ・   | F R P 浄化槽 | ・         | 動力盤、制御盤 | ・       | プロワー | ・    | さく井 | ・   | スクリーン | ・     | その他 | ◎   | スリーブ (つば付鋼管) | ・            | ◎ 印の付いたものを適用する。 |                 |
| 名             | 称   |          |   |   |   |   |   |     |     |     |     |     |     |      |      |     |     |    |    |     |     |        |        |     |     |       |       |      |      |        |        |        |        |       |       |      |      |     |     |      |      |     |     |      |      |             |             |           |           |             |             |     |     |      |      |         |         |       |       |       |       |              |              |      |      |    |    |          |          |     |     |           |           |         |         |      |      |     |     |       |       |     |     |              |              |                 |                 |
| ◎             | 配管類   |          |   |   |   |   |   |     |     |     |     |     |     |      |      |     |     |    |    |     |     |        |        |     |     |       |       |      |      |        |        |        |        |       |       |      |      |     |     |      |      |     |     |      |      |             |             |           |           |             |             |     |     |      |      |         |         |       |       |       |       |              |              |      |      |    |    |          |          |     |     |           |           |         |         |      |      |     |     |       |       |     |     |              |              |                 |                 |
| ◎             | 給水管   |          |   |   |   |   |   |     |     |     |     |     |     |      |      |     |     |    |    |     |     |        |        |     |     |       |       |      |      |        |        |        |        |       |       |      |      |     |     |      |      |     |     |      |      |             |             |           |           |             |             |     |     |      |      |         |         |       |       |       |       |              |              |      |      |    |    |          |          |     |     |           |           |         |         |      |      |     |     |       |       |     |     |              |              |                 |                 |
| ◎             | 排水管   |          |   |   |   |   |   |     |     |     |     |     |     |      |      |     |     |    |    |     |     |        |        |     |     |       |       |      |      |        |        |        |        |       |       |      |      |     |     |      |      |     |     |      |      |             |             |           |           |             |             |     |     |      |      |         |         |       |       |       |       |              |              |      |      |    |    |          |          |     |     |           |           |         |         |      |      |     |     |       |       |     |     |              |              |                 |                 |
| ◎             | 冷温水管  |          |   |   |   |   |   |     |     |     |     |     |     |      |      |     |     |    |    |     |     |        |        |     |     |       |       |      |      |        |        |        |        |       |       |      |      |     |     |      |      |     |     |      |      |             |             |           |           |             |             |     |     |      |      |         |         |       |       |       |       |              |              |      |      |    |    |          |          |     |     |           |           |         |         |      |      |     |     |       |       |     |     |              |              |                 |                 |
| ◎             | 冷煤管   |          |   |   |   |   |   |     |     |     |     |     |     |      |      |     |     |    |    |     |     |        |        |     |     |       |       |      |      |        |        |        |        |       |       |      |      |     |     |      |      |     |     |      |      |             |             |           |           |             |             |     |     |      |      |         |         |       |       |       |       |              |              |      |      |    |    |          |          |     |     |           |           |         |         |      |      |     |     |       |       |     |     |              |              |                 |                 |
| ・             | 弁類  |          |   |   |   |   |   |     |     |     |     |     |     |      |      |     |     |    |    |     |     |        |        |     |     |       |       |      |      |        |        |        |        |       |       |      |      |     |     |      |      |     |     |      |      |             |             |           |           |             |             |     |     |      |      |         |         |       |       |       |       |              |              |      |      |    |    |          |          |     |     |           |           |         |         |      |      |     |     |       |       |     |     |              |              |                 |                 |
| ◎             | 仕切弁   |          |   |   |   |   |   |     |     |     |     |     |     |      |      |     |     |    |    |     |     |        |        |     |     |       |       |      |      |        |        |        |        |       |       |      |      |     |     |      |      |     |     |      |      |             |             |           |           |             |             |     |     |      |      |         |         |       |       |       |       |              |              |      |      |    |    |          |          |     |     |           |           |         |         |      |      |     |     |       |       |     |     |              |              |                 |                 |
| ・             | バタフライ弁  |          |   |   |   |   |   |     |     |     |     |     |     |      |      |     |     |    |    |     |     |        |        |     |     |       |       |      |      |        |        |        |        |       |       |      |      |     |     |      |      |     |     |      |      |             |             |           |           |             |             |     |     |      |      |         |         |       |       |       |       |              |              |      |      |    |    |          |          |     |     |           |           |         |         |      |      |     |     |       |       |     |     |              |              |                 |                 |
| ◎             | 逆止弁   |          |   |   |   |   |   |     |     |     |     |     |     |      |      |     |     |    |    |     |     |        |        |     |     |       |       |      |      |        |        |        |        |       |       |      |      |     |     |      |      |     |     |      |      |             |             |           |           |             |             |     |     |      |      |         |         |       |       |       |       |              |              |      |      |    |    |          |          |     |     |           |           |         |         |      |      |     |     |       |       |     |     |              |              |                 |                 |
| ◎             | 緊急遮断弁   |          |   |   |   |   |   |     |     |     |     |     |     |      |      |     |     |    |    |     |     |        |        |     |     |       |       |      |      |        |        |        |        |       |       |      |      |     |     |      |      |     |     |      |      |             |             |           |           |             |             |     |     |      |      |         |         |       |       |       |       |              |              |      |      |    |    |          |          |     |     |           |           |         |         |      |      |     |     |       |       |     |     |              |              |                 |                 |
| ・             | ポンプ類  |          |   |   |   |   |   |     |     |     |     |     |     |      |      |     |     |    |    |     |     |        |        |     |     |       |       |      |      |        |        |        |        |       |       |      |      |     |     |      |      |     |     |      |      |             |             |           |           |             |             |     |     |      |      |         |         |       |       |       |       |              |              |      |      |    |    |          |          |     |     |           |           |         |         |      |      |     |     |       |       |     |     |              |              |                 |                 |
| ◎             | 給水用ポンプ  |          |   |   |   |   |   |     |     |     |     |     |     |      |      |     |     |    |    |     |     |        |        |     |     |       |       |      |      |        |        |        |        |       |       |      |      |     |     |      |      |     |     |      |      |             |             |           |           |             |             |     |     |      |      |         |         |       |       |       |       |              |              |      |      |    |    |          |          |     |     |           |           |         |         |      |      |     |     |       |       |     |     |              |              |                 |                 |
| ・             | 空調用ポンプ  |          |   |   |   |   |   |     |     |     |     |     |     |      |      |     |     |    |    |     |     |        |        |     |     |       |       |      |      |        |        |        |        |       |       |      |      |     |     |      |      |     |     |      |      |             |             |           |           |             |             |     |     |      |      |         |         |       |       |       |       |              |              |      |      |    |    |          |          |     |     |           |           |         |         |      |      |     |     |       |       |     |     |              |              |                 |                 |
| ・             | 消火ポンプ   |          |   |   |   |   |   |     |     |     |     |     |     |      |      |     |     |    |    |     |     |        |        |     |     |       |       |      |      |        |        |        |        |       |       |      |      |     |     |      |      |     |     |      |      |             |             |           |           |             |             |     |     |      |      |         |         |       |       |       |       |              |              |      |      |    |    |          |          |     |     |           |           |         |         |      |      |     |     |       |       |     |     |              |              |                 |                 |
| ・             | タンク類  |          |   |   |   |   |   |     |     |     |     |     |     |      |      |     |     |    |    |     |     |        |        |     |     |       |       |      |      |        |        |        |        |       |       |      |      |     |     |      |      |     |     |      |      |             |             |           |           |             |             |     |     |      |      |         |         |       |       |       |       |              |              |      |      |    |    |          |          |     |     |           |           |         |         |      |      |     |     |       |       |     |     |              |              |                 |                 |
| ◎             | 受水槽   |          |   |   |   |   |   |     |     |     |     |     |     |      |      |     |     |    |    |     |     |        |        |     |     |       |       |      |      |        |        |        |        |       |       |      |      |     |     |      |      |     |     |      |      |             |             |           |           |             |             |     |     |      |      |         |         |       |       |       |       |              |              |      |      |    |    |          |          |     |     |           |           |         |         |      |      |     |     |       |       |     |     |              |              |                 |                 |
| ・             | 高架水槽  |          |   |   |   |   |   |     |     |     |     |     |     |      |      |     |     |    |    |     |     |        |        |     |     |       |       |      |      |        |        |        |        |       |       |      |      |     |     |      |      |     |     |      |      |             |             |           |           |             |             |     |     |      |      |         |         |       |       |       |       |              |              |      |      |    |    |          |          |     |     |           |           |         |         |      |      |     |     |       |       |     |     |              |              |                 |                 |
| ・             | 貯湯槽   |          |   |   |   |   |   |     |     |     |     |     |     |      |      |     |     |    |    |     |     |        |        |     |     |       |       |      |      |        |        |        |        |       |       |      |      |     |     |      |      |     |     |      |      |             |             |           |           |             |             |     |     |      |      |         |         |       |       |       |       |              |              |      |      |    |    |          |          |     |     |           |           |         |         |      |      |     |     |       |       |     |     |              |              |                 |                 |
| ・             | 膨張水槽  |          |   |   |   |   |   |     |     |     |     |     |     |      |      |     |     |    |    |     |     |        |        |     |     |       |       |      |      |        |        |        |        |       |       |      |      |     |     |      |      |     |     |      |      |             |             |           |           |             |             |     |     |      |      |         |         |       |       |       |       |              |              |      |      |    |    |          |          |     |     |           |           |         |         |      |      |     |     |       |       |     |     |              |              |                 |                 |
| ・             | 空気調和設備工事用機材   |          |   |   |   |   |   |     |     |     |     |     |     |      |      |     |     |    |    |     |     |        |        |     |     |       |       |      |      |        |        |        |        |       |       |      |      |     |     |      |      |     |     |      |      |             |             |           |           |             |             |     |     |      |      |         |         |       |       |       |       |              |              |      |      |    |    |          |          |     |     |           |           |         |         |      |      |     |     |       |       |     |     |              |              |                 |                 |
| ◎             | パッケージエアコン   |          |   |   |   |   |   |     |     |     |     |     |     |      |      |     |     |    |    |     |     |        |        |     |     |       |       |      |      |        |        |        |        |       |       |      |      |     |     |      |      |     |     |      |      |             |             |           |           |             |             |     |     |      |      |         |         |       |       |       |       |              |              |      |      |    |    |          |          |     |     |           |           |         |         |      |      |     |     |       |       |     |     |              |              |                 |                 |
| ・             | 空気調和機 (AHU)   |          |   |   |   |   |   |     |     |     |     |     |     |      |      |     |     |    |    |     |     |        |        |     |     |       |       |      |      |        |        |        |        |       |       |      |      |     |     |      |      |     |     |      |      |             |             |           |           |             |             |     |     |      |      |         |         |       |       |       |       |              |              |      |      |    |    |          |          |     |     |           |           |         |         |      |      |     |     |       |       |     |     |              |              |                 |                 |
| ・             | 冷却塔   |          |   |   |   |   |   |     |     |     |     |     |     |      |      |     |     |    |    |     |     |        |        |     |     |       |       |      |      |        |        |        |        |       |       |      |      |     |     |      |      |     |     |      |      |             |             |           |           |             |             |     |     |      |      |         |         |       |       |       |       |              |              |      |      |    |    |          |          |     |     |           |           |         |         |      |      |     |     |       |       |     |     |              |              |                 |                 |
| ・             | ヘッダー  |          |   |   |   |   |   |     |     |     |     |     |     |      |      |     |     |    |    |     |     |        |        |     |     |       |       |      |      |        |        |        |        |       |       |      |      |     |     |      |      |     |     |      |      |             |             |           |           |             |             |     |     |      |      |         |         |       |       |       |       |              |              |      |      |    |    |          |          |     |     |           |           |         |         |      |      |     |     |       |       |     |     |              |              |                 |                 |
| ・             | 自動制御機器類   |          |   |   |   |   |   |     |     |     |     |     |     |      |      |     |     |    |    |     |     |        |        |     |     |       |       |      |      |        |        |        |        |       |       |      |      |     |     |      |      |     |     |      |      |             |             |           |           |             |             |     |     |      |      |         |         |       |       |       |       |              |              |      |      |    |    |          |          |     |     |           |           |         |         |      |      |     |     |       |       |     |     |              |              |                 |                 |
| ・             | 中央監視盤   |          |   |   |   |   |   |     |     |     |     |     |     |      |      |     |     |    |    |     |     |        |        |     |     |       |       |      |      |        |        |        |        |       |       |      |      |     |     |      |      |     |     |      |      |             |             |           |           |             |             |     |     |      |      |         |         |       |       |       |       |              |              |      |      |    |    |          |          |     |     |           |           |         |         |      |      |     |     |       |       |     |     |              |              |                 |                 |
| ・             | リモート盤   |          |   |   |   |   |   |     |     |     |     |     |     |      |      |     |     |    |    |     |     |        |        |     |     |       |       |      |      |        |        |        |        |       |       |      |      |     |     |      |      |     |     |      |      |             |             |           |           |             |             |     |     |      |      |         |         |       |       |       |       |              |              |      |      |    |    |          |          |     |     |           |           |         |         |      |      |     |     |       |       |     |     |              |              |                 |                 |
| ・             | 給排水衛生設備工事用機材  |          |   |   |   |   |   |     |     |     |     |     |     |      |      |     |     |    |    |     |     |        |        |     |     |       |       |      |      |        |        |        |        |       |       |      |      |     |     |      |      |     |     |      |      |             |             |           |           |             |             |     |     |      |      |         |         |       |       |       |       |              |              |      |      |    |    |          |          |     |     |           |           |         |         |      |      |     |     |       |       |     |     |              |              |                 |                 |
| ◎             | 衛生器具  |          |   |   |   |   |   |     |     |     |     |     |     |      |      |     |     |    |    |     |     |        |        |     |     |       |       |      |      |        |        |        |        |       |       |      |      |     |     |      |      |     |     |      |      |             |             |           |           |             |             |     |     |      |      |         |         |       |       |       |       |              |              |      |      |    |    |          |          |     |     |           |           |         |         |      |      |     |     |       |       |     |     |              |              |                 |                 |
| ◎             | 水栓  |          |   |   |   |   |   |     |     |     |     |     |     |      |      |     |     |    |    |     |     |        |        |     |     |       |       |      |      |        |        |        |        |       |       |      |      |     |     |      |      |     |     |      |      |             |             |           |           |             |             |     |     |      |      |         |         |       |       |       |       |              |              |      |      |    |    |          |          |     |     |           |           |         |         |      |      |     |     |       |       |     |     |              |              |                 |                 |
| ◎             | 組立てマンホール  |          |   |   |   |   |   |     |     |     |     |     |     |      |      |     |     |    |    |     |     |        |        |     |     |       |       |      |      |        |        |        |        |       |       |      |      |     |     |      |      |     |     |      |      |             |             |           |           |             |             |     |     |      |      |         |         |       |       |       |       |              |              |      |      |    |    |          |          |     |     |           |           |         |         |      |      |     |     |       |       |     |     |              |              |                 |                 |
| ・             | 浄化槽   |          |   |   |   |   |   |     |     |     |     |     |     |      |      |     |     |    |    |     |     |        |        |     |     |       |       |      |      |        |        |        |        |       |       |      |      |     |     |      |      |     |     |      |      |             |             |           |           |             |             |     |     |      |      |         |         |       |       |       |       |              |              |      |      |    |    |          |          |     |     |           |           |         |         |      |      |     |     |       |       |     |     |              |              |                 |                 |
| ・             | F R P 浄化槽   |          |   |   |   |   |   |     |     |     |     |     |     |      |      |     |     |    |    |     |     |        |        |     |     |       |       |      |      |        |        |        |        |       |       |      |      |     |     |      |      |     |     |      |      |             |             |           |           |             |             |     |     |      |      |         |         |       |       |       |       |              |              |      |      |    |    |          |          |     |     |           |           |         |         |      |      |     |     |       |       |     |     |              |              |                 |                 |
| ・             | 動力盤、制御盤   |          |   |   |   |   |   |     |     |     |     |     |     |      |      |     |     |    |    |     |     |        |        |     |     |       |       |      |      |        |        |        |        |       |       |      |      |     |     |      |      |     |     |      |      |             |             |           |           |             |             |     |     |      |      |         |         |       |       |       |       |              |              |      |      |    |    |          |          |     |     |           |           |         |         |      |      |     |     |       |       |     |     |              |              |                 |                 |
| ・             | プロワー  |          |   |   |   |   |   |     |     |     |     |     |     |      |      |     |     |    |    |     |     |        |        |     |     |       |       |      |      |        |        |        |        |       |       |      |      |     |     |      |      |     |     |      |      |             |             |           |           |             |             |     |     |      |      |         |         |       |       |       |       |              |              |      |      |    |    |          |          |     |     |           |           |         |         |      |      |     |     |       |       |     |     |              |              |                 |                 |
| ・             | さく井   |          |   |   |   |   |   |     |     |     |     |     |     |      |      |     |     |    |    |     |     |        |        |     |     |       |       |      |      |        |        |        |        |       |       |      |      |     |     |      |      |     |     |      |      |             |             |           |           |             |             |     |     |      |      |         |         |       |       |       |       |              |              |      |      |    |    |          |          |     |     |           |           |         |         |      |      |     |     |       |       |     |     |              |              |                 |                 |
| ・             | スクリーン   |          |   |   |   |   |   |     |     |     |     |     |     |      |      |     |     |    |    |     |     |        |        |     |     |       |       |      |      |        |        |        |        |       |       |      |      |     |     |      |      |     |     |      |      |             |             |           |           |             |             |     |     |      |      |         |         |       |       |       |       |              |              |      |      |    |    |          |          |     |     |           |           |         |         |      |      |     |     |       |       |     |     |              |              |                 |                 |
| ・             | その他   |          |   |   |   |   |   |     |     |     |     |     |     |      |      |     |     |    |    |     |     |        |        |     |     |       |       |      |      |        |        |        |        |       |       |      |      |     |     |      |      |     |     |      |      |             |             |           |           |             |             |     |     |      |      |         |         |       |       |       |       |              |              |      |      |    |    |          |          |     |     |           |           |         |         |      |      |     |     |       |       |     |     |              |              |                 |                 |
| ◎             | スリーブ (つば付鋼管)  |          |   |   |   |   |   |     |     |     |     |     |     |      |      |     |     |    |    |     |     |        |        |     |     |       |       |      |      |        |        |        |        |       |       |      |      |     |     |      |      |     |     |      |      |             |             |           |           |             |             |     |     |      |      |         |         |       |       |       |       |              |              |      |      |    |    |          |          |     |     |           |           |         |         |      |      |     |     |       |       |     |     |              |              |                 |                 |
| ・             | ◎ 印の付いたものを適用する。   |          |   |   |   |   |   |     |     |     |     |     |     |      |      |     |     |    |    |     |     |        |        |     |     |       |       |      |      |        |        |        |        |       |       |      |      |     |     |      |      |     |     |      |      |             |             |           |           |             |             |     |     |      |      |         |         |       |       |       |       |              |              |      |      |    |    |          |          |     |     |           |           |         |         |      |      |     |     |       |       |     |     |              |              |                 |                 |
| 屋内給水設備        | 1 配管材料 屋内一般 ※ 水道用硬質塩化ビニルライニング鋼管 (VB)<br>◎ 図示による<br>地中埋設 ※ 水道用硬質塩化ビニルライニング鋼管 (VD)<br>◎ 図示による<br>2 配管接合 ねじ接合 ※ 100A 以下 ・ A 以下<br>フランジ接合 ※ 125A 以上 ・ A 以上 ( FVB, FVD とする )   | 撤去工事     | 1 冷媒 (フロン系) の回収 ※ 無 ・ 有<br>(1) 冷媒の回収にあたっては、「フロン類の使用の合理化及び管理の適正化に関する法律 (フロン排出抑制法)」に従って行うこと。<br>また、法に規定するものの他、次の書類を監督職員に提出すること。<br>(ア) 第一種フロン類充填回収業者登録通知書の写し<br>(イ) フロン類の処理に関する証明書 (充填証明書、引取証明書等)<br>(2) 行程管理票の様式は、監督職員の指示による。<br>2 家庭用エアコンの処分 家庭用のエアコン等で「特定家庭用機器再商品化法 (家電リサイクル法)」の対象となっているものは、本工事では撤去までとし、処分等については、施設管理者へ引き渡しを行う。<br>3 吸収冷凍機、吸収冷温水機等の美化リチウム水溶液等 ※ 無 ・ 有<br>関係法令に従い、専門業者により適正に処理すること。<br>4 石綿含有建材の除去工事 事前調査 ※ 行う ・ 行わない<br>工事着手に先立ち、目視及び貸与する設計図書等により石綿を含有している建築材料等の使用の有無について調査する。<br>分析による石綿含有建材の調査 ※ 行わない ・ 行う ( 箇所 )<br>測定箇所等は監督職員の指示による。<br>石綿粉じん濃度測定 ※ 行わない ・ 行う ( 箇所 )<br>測定箇所等は監督職員の指示による。<br>石綿作業主任者 石綿作業主任者技能講習修了者又は平成18年3月以前の特定化学物質作業主任者の有資格者の内から選任し、法令に基づき、作業の方法、労働者の指導等必要な措置を行うこと。<br>石綿含有品 ・ フランジ用ガasket ( ・ 配管 ・ ダクト )<br>・ 配管成形保温材<br>・ 天井材<br>・ 外壁 ( ・ 塗材 ・ スレート ・ )<br>撤去部にアスベストを含む材料が使用されている場合は、適切に処理を行い、必要に応じて官公庁等への届出を行うこと。<br>石綿含有塗材の塗布された外壁及び石綿含有スレート 波板等の外壁面に対して、足場及び配管等の支持のため、アンカーを打設する際にも、石綿作業主任者を配置し、外壁面に対して湿潤状態とし、集塵機付き電動工具を使用する等、飛散防止措置を講ずること。 | <p>別表 1</p> <table border="1"> <tr><th>名</th><th>称</th></tr> <tr><td>◎</td><td>配管類</td></tr> <tr><td>◎</td><td>給水管</td></tr> <tr><td>◎</td><td>排水管</td></tr> <tr><td>◎</td><td>冷温水管</td></tr> <tr><td>◎</td><td>冷煤管</td></tr> <tr><td>・</td><td>弁類</td></tr> <tr><td>◎</td><td>仕切弁</td></tr> <tr><td>・</td><td>バタフライ弁</td></tr> <tr><td>◎</td><td>逆止弁</td></tr> <tr><td>◎</td><td>緊急遮断弁</td></tr> <tr><td>・</td><td>ポンプ類</td></tr> <tr><td>◎</td><td>給水用ポンプ</td></tr> <tr><td>・</td><td>空調用ポンプ</td></tr> <tr><td>・</td><td>消火ポンプ</td></tr> <tr><td>・</td><td>タンク類</td></tr> <tr><td>◎</td><td>受水槽</td></tr> <tr><td>・</td><td>高架水槽</td></tr> <tr><td>・</td><td>貯湯槽</td></tr> <tr><td>・</td><td>膨張水槽</td></tr> <tr><td>・</td><td>空気調和設備工事用機材</td></tr> <tr><td>◎</td><td>パッケージエアコン</td></tr> <tr><td>・</td><td>空気調和機 (AHU)</td></tr> <tr><td>・</td><td>冷却塔</td></tr> <tr><td>・</td><td>ヘッダー</td></tr> <tr><td>・</td><td>自動制御機器類</td></tr> <tr><td>・</td><td>中央監視盤</td></tr> <tr><td>・</td><td>リモート盤</td></tr> <tr><td>・</td><td>給排水衛生設備工事用機材</td></tr> <tr><td>◎</td><td>衛生器具</td></tr> <tr><td>◎</td><td>水栓</td></tr> <tr><td>◎</td><td>組立てマンホール</td></tr> <tr><td>・</td><td>浄化槽</td></tr> <tr><td>・</td><td>F R P 浄化槽</td></tr> <tr><td>・</td><td>動力盤、制御盤</td></tr> <tr><td>・</td><td>プロワー</td></tr> <tr><td>・</td><td>さく井</td></tr> <tr><td>・</td><td>スクリーン</td></tr> <tr><td>・</td><td>その他</td></tr> <tr><td>◎</td><td>スリーブ (つば付鋼管)</td></tr> <tr><td>・</td><td>◎ 印の付いたものを適用する。</td></tr> </table> | 名   | 称   | ◎ | 配管類 | ◎   | 給水管 | ◎   | 排水管 | ◎   | 冷温水管 | ◎    | 冷煤管 | ・   | 弁類 | ◎  | 仕切弁 | ・   | バタフライ弁 | ◎      | 逆止弁 | ◎   | 緊急遮断弁 | ・     | ポンプ類 | ◎    | 給水用ポンプ | ・      | 空調用ポンプ | ・      | 消火ポンプ | ・     | タンク類 | ◎    | 受水槽 | ・   | 高架水槽 | ・    | 貯湯槽 | ・   | 膨張水槽 | ・    | 空気調和設備工事用機材 | ◎           | パッケージエアコン | ・         | 空気調和機 (AHU) | ・           | 冷却塔 | ・   | ヘッダー | ・    | 自動制御機器類 | ・       | 中央監視盤 | ・     | リモート盤 | ・     | 給排水衛生設備工事用機材 | ◎            | 衛生器具 | ◎    | 水栓 | ◎  | 組立てマンホール | ・        | 浄化槽 | ・   | F R P 浄化槽 | ・         | 動力盤、制御盤 | ・       | プロワー | ・    | さく井 | ・   | スクリーン | ・     | その他 | ◎   | スリーブ (つば付鋼管) | ・            | ◎ 印の付いたものを適用する。 |                 |
| 名             | 称   |          |   |   |   |   |   |     |     |     |     |     |     |      |      |     |     |    |    |     |     |        |        |     |     |       |       |      |      |        |        |        |        |       |       |      |      |     |     |      |      |     |     |      |      |             |             |           |           |             |             |     |     |      |      |         |         |       |       |       |       |              |              |      |      |    |    |          |          |     |     |           |           |         |         |      |      |     |     |       |       |     |     |              |              |                 |                 |
| ◎             | 配管類   |          |   |   |   |   |   |     |     |     |     |     |     |      |      |     |     |    |    |     |     |        |        |     |     |       |       |      |      |        |        |        |        |       |       |      |      |     |     |      |      |     |     |      |      |             |             |           |           |             |             |     |     |      |      |         |         |       |       |       |       |              |              |      |      |    |    |          |          |     |     |           |           |         |         |      |      |     |     |       |       |     |     |              |              |                 |                 |
| ◎             | 給水管   |          |   |   |   |   |   |     |     |     |     |     |     |      |      |     |     |    |    |     |     |        |        |     |     |       |       |      |      |        |        |        |        |       |       |      |      |     |     |      |      |     |     |      |      |             |             |           |           |             |             |     |     |      |      |         |         |       |       |       |       |              |              |      |      |    |    |          |          |     |     |           |           |         |         |      |      |     |     |       |       |     |     |              |              |                 |                 |
| ◎             | 排水管   |          |   |   |   |   |   |     |     |     |     |     |     |      |      |     |     |    |    |     |     |        |        |     |     |       |       |      |      |        |        |        |        |       |       |      |      |     |     |      |      |     |     |      |      |             |             |           |           |             |             |     |     |      |      |         |         |       |       |       |       |              |              |      |      |    |    |          |          |     |     |           |           |         |         |      |      |     |     |       |       |     |     |              |              |                 |                 |
| ◎             | 冷温水管  |          |   |   |   |   |   |     |     |     |     |     |     |      |      |     |     |    |    |     |     |        |        |     |     |       |       |      |      |        |        |        |        |       |       |      |      |     |     |      |      |     |     |      |      |             |             |           |           |             |             |     |     |      |      |         |         |       |       |       |       |              |              |      |      |    |    |          |          |     |     |           |           |         |         |      |      |     |     |       |       |     |     |              |              |                 |                 |
| ◎             | 冷煤管   |          |   |   |   |   |   |     |     |     |     |     |     |      |      |     |     |    |    |     |     |        |        |     |     |       |       |      |      |        |        |        |        |       |       |      |      |     |     |      |      |     |     |      |      |             |             |           |           |             |             |     |     |      |      |         |         |       |       |       |       |              |              |      |      |    |    |          |          |     |     |           |           |         |         |      |      |     |     |       |       |     |     |              |              |                 |                 |
| ・             | 弁類  |          |   |   |   |   |   |     |     |     |     |     |     |      |      |     |     |    |    |     |     |        |        |     |     |       |       |      |      |        |        |        |        |       |       |      |      |     |     |      |      |     |     |      |      |             |             |           |           |             |             |     |     |      |      |         |         |       |       |       |       |              |              |      |      |    |    |          |          |     |     |           |           |         |         |      |      |     |     |       |       |     |     |              |              |                 |                 |
| ◎             | 仕切弁   |          |   |   |   |   |   |     |     |     |     |     |     |      |      |     |     |    |    |     |     |        |        |     |     |       |       |      |      |        |        |        |        |       |       |      |      |     |     |      |      |     |     |      |      |             |             |           |           |             |             |     |     |      |      |         |         |       |       |       |       |              |              |      |      |    |    |          |          |     |     |           |           |         |         |      |      |     |     |       |       |     |     |              |              |                 |                 |
| ・             | バタフライ弁  |          |   |   |   |   |   |     |     |     |     |     |     |      |      |     |     |    |    |     |     |        |        |     |     |       |       |      |      |        |        |        |        |       |       |      |      |     |     |      |      |     |     |      |      |             |             |           |           |             |             |     |     |      |      |         |         |       |       |       |       |              |              |      |      |    |    |          |          |     |     |           |           |         |         |      |      |     |     |       |       |     |     |              |              |                 |                 |
| ◎             | 逆止弁   |          |   |   |   |   |   |     |     |     |     |     |     |      |      |     |     |    |    |     |     |        |        |     |     |       |       |      |      |        |        |        |        |       |       |      |      |     |     |      |      |     |     |      |      |             |             |           |           |             |             |     |     |      |      |         |         |       |       |       |       |              |              |      |      |    |    |          |          |     |     |           |           |         |         |      |      |     |     |       |       |     |     |              |              |                 |                 |
| ◎             | 緊急遮断弁   |          |   |   |   |   |   |     |     |     |     |     |     |      |      |     |     |    |    |     |     |        |        |     |     |       |       |      |      |        |        |        |        |       |       |      |      |     |     |      |      |     |     |      |      |             |             |           |           |             |             |     |     |      |      |         |         |       |       |       |       |              |              |      |      |    |    |          |          |     |     |           |           |         |         |      |      |     |     |       |       |     |     |              |              |                 |                 |
| ・             | ポンプ類  |          |   |   |   |   |   |     |     |     |     |     |     |      |      |     |     |    |    |     |     |        |        |     |     |       |       |      |      |        |        |        |        |       |       |      |      |     |     |      |      |     |     |      |      |             |             |           |           |             |             |     |     |      |      |         |         |       |       |       |       |              |              |      |      |    |    |          |          |     |     |           |           |         |         |      |      |     |     |       |       |     |     |              |              |                 |                 |
| ◎             | 給水用ポンプ  |          |   |   |   |   |   |     |     |     |     |     |     |      |      |     |     |    |    |     |     |        |        |     |     |       |       |      |      |        |        |        |        |       |       |      |      |     |     |      |      |     |     |      |      |             |             |           |           |             |             |     |     |      |      |         |         |       |       |       |       |              |              |      |      |    |    |          |          |     |     |           |           |         |         |      |      |     |     |       |       |     |     |              |              |                 |                 |
| ・             | 空調用ポンプ  |          |   |   |   |   |   |     |     |     |     |     |     |      |      |     |     |    |    |     |     |        |        |     |     |       |       |      |      |        |        |        |        |       |       |      |      |     |     |      |      |     |     |      |      |             |             |           |           |             |             |     |     |      |      |         |         |       |       |       |       |              |              |      |      |    |    |          |          |     |     |           |           |         |         |      |      |     |     |       |       |     |     |              |              |                 |                 |
| ・             | 消火ポンプ   |          |   |   |   |   |   |     |     |     |     |     |     |      |      |     |     |    |    |     |     |        |        |     |     |       |       |      |      |        |        |        |        |       |       |      |      |     |     |      |      |     |     |      |      |             |             |           |           |             |             |     |     |      |      |         |         |       |       |       |       |              |              |      |      |    |    |          |          |     |     |           |           |         |         |      |      |     |     |       |       |     |     |              |              |                 |                 |
| ・             | タンク類  |          |   |   |   |   |   |     |     |     |     |     |     |      |      |     |     |    |    |     |     |        |        |     |     |       |       |      |      |        |        |        |        |       |       |      |      |     |     |      |      |     |     |      |      |             |             |           |           |             |             |     |     |      |      |         |         |       |       |       |       |              |              |      |      |    |    |          |          |     |     |           |           |         |         |      |      |     |     |       |       |     |     |              |              |                 |                 |
| ◎             | 受水槽   |          |   |   |   |   |   |     |     |     |     |     |     |      |      |     |     |    |    |     |     |        |        |     |     |       |       |      |      |        |        |        |        |       |       |      |      |     |     |      |      |     |     |      |      |             |             |           |           |             |             |     |     |      |      |         |         |       |       |       |       |              |              |      |      |    |    |          |          |     |     |           |           |         |         |      |      |     |     |       |       |     |     |              |              |                 |                 |
| ・             | 高架水槽  |          |   |   |   |   |   |     |     |     |     |     |     |      |      |     |     |    |    |     |     |        |        |     |     |       |       |      |      |        |        |        |        |       |       |      |      |     |     |      |      |     |     |      |      |             |             |           |           |             |             |     |     |      |      |         |         |       |       |       |       |              |              |      |      |    |    |          |          |     |     |           |           |         |         |      |      |     |     |       |       |     |     |              |              |                 |                 |
| ・             | 貯湯槽   |          |   |   |   |   |   |     |     |     |     |     |     |      |      |     |     |    |    |     |     |        |        |     |     |       |       |      |      |        |        |        |        |       |       |      |      |     |     |      |      |     |     |      |      |             |             |           |           |             |             |     |     |      |      |         |         |       |       |       |       |              |              |      |      |    |    |          |          |     |     |           |           |         |         |      |      |     |     |       |       |     |     |              |              |                 |                 |
| ・             | 膨張水槽  |          |   |   |   |   |   |     |     |     |     |     |     |      |      |     |     |    |    |     |     |        |        |     |     |       |       |      |      |        |        |        |        |       |       |      |      |     |     |      |      |     |     |      |      |             |             |           |           |             |             |     |     |      |      |         |         |       |       |       |       |              |              |      |      |    |    |          |          |     |     |           |           |         |         |      |      |     |     |       |       |     |     |              |              |                 |                 |
| ・             | 空気調和設備工事用機材   |          |   |   |   |   |   |     |     |     |     |     |     |      |      |     |     |    |    |     |     |        |        |     |     |       |       |      |      |        |        |        |        |       |       |      |      |     |     |      |      |     |     |      |      |             |             |           |           |             |             |     |     |      |      |         |         |       |       |       |       |              |              |      |      |    |    |          |          |     |     |           |           |         |         |      |      |     |     |       |       |     |     |              |              |                 |                 |
| ◎             | パッケージエアコン   |          |   |   |   |   |   |     |     |     |     |     |     |      |      |     |     |    |    |     |     |        |        |     |     |       |       |      |      |        |        |        |        |       |       |      |      |     |     |      |      |     |     |      |      |             |             |           |           |             |             |     |     |      |      |         |         |       |       |       |       |              |              |      |      |    |    |          |          |     |     |           |           |         |         |      |      |     |     |       |       |     |     |              |              |                 |                 |
| ・             | 空気調和機 (AHU)   |          |   |   |   |   |   |     |     |     |     |     |     |      |      |     |     |    |    |     |     |        |        |     |     |       |       |      |      |        |        |        |        |       |       |      |      |     |     |      |      |     |     |      |      |             |             |           |           |             |             |     |     |      |      |         |         |       |       |       |       |              |              |      |      |    |    |          |          |     |     |           |           |         |         |      |      |     |     |       |       |     |     |              |              |                 |                 |
| ・             | 冷却塔   |          |   |   |   |   |   |     |     |     |     |     |     |      |      |     |     |    |    |     |     |        |        |     |     |       |       |      |      |        |        |        |        |       |       |      |      |     |     |      |      |     |     |      |      |             |             |           |           |             |             |     |     |      |      |         |         |       |       |       |       |              |              |      |      |    |    |          |          |     |     |           |           |         |         |      |      |     |     |       |       |     |     |              |              |                 |                 |
| ・             | ヘッダー  |          |   |   |   |   |   |     |     |     |     |     |     |      |      |     |     |    |    |     |     |        |        |     |     |       |       |      |      |        |        |        |        |       |       |      |      |     |     |      |      |     |     |      |      |             |             |           |           |             |             |     |     |      |      |         |         |       |       |       |       |              |              |      |      |    |    |          |          |     |     |           |           |         |         |      |      |     |     |       |       |     |     |              |              |                 |                 |
| ・             | 自動制御機器類   |          |   |   |   |   |   |     |     |     |     |     |     |      |      |     |     |    |    |     |     |        |        |     |     |       |       |      |      |        |        |        |        |       |       |      |      |     |     |      |      |     |     |      |      |             |             |           |           |             |             |     |     |      |      |         |         |       |       |       |       |              |              |      |      |    |    |          |          |     |     |           |           |         |         |      |      |     |     |       |       |     |     |              |              |                 |                 |
| ・             | 中央監視盤   |          |   |   |   |   |   |     |     |     |     |     |     |      |      |     |     |    |    |     |     |        |        |     |     |       |       |      |      |        |        |        |        |       |       |      |      |     |     |      |      |     |     |      |      |             |             |           |           |             |             |     |     |      |      |         |         |       |       |       |       |              |              |      |      |    |    |          |          |     |     |           |           |         |         |      |      |     |     |       |       |     |     |              |              |                 |                 |
| ・             | リモート盤   |          |   |   |   |   |   |     |     |     |     |     |     |      |      |     |     |    |    |     |     |        |        |     |     |       |       |      |      |        |        |        |        |       |       |      |      |     |     |      |      |     |     |      |      |             |             |           |           |             |             |     |     |      |      |         |         |       |       |       |       |              |              |      |      |    |    |          |          |     |     |           |           |         |         |      |      |     |     |       |       |     |     |              |              |                 |                 |
| ・             | 給排水衛生設備工事用機材  |          |   |   |   |   |   |     |     |     |     |     |     |      |      |     |     |    |    |     |     |        |        |     |     |       |       |      |      |        |        |        |        |       |       |      |      |     |     |      |      |     |     |      |      |             |             |           |           |             |             |     |     |      |      |         |         |       |       |       |       |              |              |      |      |    |    |          |          |     |     |           |           |         |         |      |      |     |     |       |       |     |     |              |              |                 |                 |
| ◎             | 衛生器具  |          |   |   |   |   |   |     |     |     |     |     |     |      |      |     |     |    |    |     |     |        |        |     |     |       |       |      |      |        |        |        |        |       |       |      |      |     |     |      |      |     |     |      |      |             |             |           |           |             |             |     |     |      |      |         |         |       |       |       |       |              |              |      |      |    |    |          |          |     |     |           |           |         |         |      |      |     |     |       |       |     |     |              |              |                 |                 |
| ◎             | 水栓  |          |   |   |   |   |   |     |     |     |     |     |     |      |      |     |     |    |    |     |     |        |        |     |     |       |       |      |      |        |        |        |        |       |       |      |      |     |     |      |      |     |     |      |      |             |             |           |           |             |             |     |     |      |      |         |         |       |       |       |       |              |              |      |      |    |    |          |          |     |     |           |           |         |         |      |      |     |     |       |       |     |     |              |              |                 |                 |
| ◎             | 組立てマンホール  |          |   |   |   |   |   |     |     |     |     |     |     |      |      |     |     |    |    |     |     |        |        |     |     |       |       |      |      |        |        |        |        |       |       |      |      |     |     |      |      |     |     |      |      |             |             |           |           |             |             |     |     |      |      |         |         |       |       |       |       |              |              |      |      |    |    |          |          |     |     |           |           |         |         |      |      |     |     |       |       |     |     |              |              |                 |                 |
| ・             | 浄化槽   |          |   |   |   |   |   |     |     |     |     |     |     |      |      |     |     |    |    |     |     |        |        |     |     |       |       |      |      |        |        |        |        |       |       |      |      |     |     |      |      |     |     |      |      |             |             |           |           |             |             |     |     |      |      |         |         |       |       |       |       |              |              |      |      |    |    |          |          |     |     |           |           |         |         |      |      |     |     |       |       |     |     |              |              |                 |                 |
| ・             | F R P 浄化槽   |          |   |   |   |   |   |     |     |     |     |     |     |      |      |     |     |    |    |     |     |        |        |     |     |       |       |      |      |        |        |        |        |       |       |      |      |     |     |      |      |     |     |      |      |             |             |           |           |             |             |     |     |      |      |         |         |       |       |       |       |              |              |      |      |    |    |          |          |     |     |           |           |         |         |      |      |     |     |       |       |     |     |              |              |                 |                 |
| ・             | 動力盤、制御盤   |          |   |   |   |   |   |     |     |     |     |     |     |      |      |     |     |    |    |     |     |        |        |     |     |       |       |      |      |        |        |        |        |       |       |      |      |     |     |      |      |     |     |      |      |             |             |           |           |             |             |     |     |      |      |         |         |       |       |       |       |              |              |      |      |    |    |          |          |     |     |           |           |         |         |      |      |     |     |       |       |     |     |              |              |                 |                 |
| ・             | プロワー  |          |   |   |   |   |   |     |     |     |     |     |     |      |      |     |     |    |    |     |     |        |        |     |     |       |       |      |      |        |        |        |        |       |       |      |      |     |     |      |      |     |     |      |      |             |             |           |           |             |             |     |     |      |      |         |         |       |       |       |       |              |              |      |      |    |    |          |          |     |     |           |           |         |         |      |      |     |     |       |       |     |     |              |              |                 |                 |
| ・             | さく井   |          |   |   |   |   |   |     |     |     |     |     |     |      |      |     |     |    |    |     |     |        |        |     |     |       |       |      |      |        |        |        |        |       |       |      |      |     |     |      |      |     |     |      |      |             |             |           |           |             |             |     |     |      |      |         |         |       |       |       |       |              |              |      |      |    |    |          |          |     |     |           |           |         |         |      |      |     |     |       |       |     |     |              |              |                 |                 |
| ・             | スクリーン   |          |   |   |   |   |   |     |     |     |     |     |     |      |      |     |     |    |    |     |     |        |        |     |     |       |       |      |      |        |        |        |        |       |       |      |      |     |     |      |      |     |     |      |      |             |             |           |           |             |             |     |     |      |      |         |         |       |       |       |       |              |              |      |      |    |    |          |          |     |     |           |           |         |         |      |      |     |     |       |       |     |     |              |              |                 |                 |
| ・             | その他   |          |   |   |   |   |   |     |     |     |     |     |     |      |      |     |     |    |    |     |     |        |        |     |     |       |       |      |      |        |        |        |        |       |       |      |      |     |     |      |      |     |     |      |      |             |             |           |           |             |             |     |     |      |      |         |         |       |       |       |       |              |              |      |      |    |    |          |          |     |     |           |           |         |         |      |      |     |     |       |       |     |     |              |              |                 |                 |
| ◎             | スリーブ (つば付鋼管)  |          |   |   |   |   |   |     |     |     |     |     |     |      |      |     |     |    |    |     |     |        |        |     |     |       |       |      |      |        |        |        |        |       |       |      |      |     |     |      |      |     |     |      |      |             |             |           |           |             |             |     |     |      |      |         |         |       |       |       |       |              |              |      |      |    |    |          |          |     |     |           |           |         |         |      |      |     |     |       |       |     |     |              |              |                 |                 |
| ・             | ◎ 印の付いたものを適用する。   |          |   |   |   |   |   |     |     |     |     |     |     |      |      |     |     |    |    |     |     |        |        |     |     |       |       |      |      |        |        |        |        |       |       |      |      |     |     |      |      |     |     |      |      |             |             |           |           |             |             |     |     |      |      |         |         |       |       |       |       |              |              |      |      |    |    |          |          |     |     |           |           |         |         |      |      |     |     |       |       |     |     |              |              |                 |                 |
| 屋外給水設備        | 1 上水道加入金 ※ 不要 ・ 要 ( ※ 別途 ・ 本工事 )<br>2 量水器 ※ 貸与品 ・ 本工事 (水道事業者の認定品)<br>3 量水器樹 ※ 水道事業者の規格 ・ 標準図 形<br>4 配管材料 地中埋設 ※ 水道用硬質塩化ビニルライニング鋼管 (VD) (40A 以下)<br>・ 水道用ポリエチレン二層管 (40A 以下)<br>◎ 図示による<br>架空 ※ 水道用硬質塩化ビニルライニング鋼管 (VB)<br>・<br>5 配管接合 ねじ接合 ※ 100A 以下 ・ A 以下<br>フランジ接合 ※ 125A 以上 ・ A 以上 ( FVB, FVD とする )<br>水道配水管ポリエチレン管は電気融着接合とする<br>6 緊急遮断弁装置 駆動方式 ※ 電気式 ・ 機械式<br>7 水圧試験 水道配水管ポリエチレン管は、配水管ポリエチレンパイプシステム協会が推奨する試験方法による。   | 撤去工事     | 1 冷媒 (フロン系) の回収 ※ 無 ・ 有<br>(1) 冷媒の回収にあたっては、「フロン類の使用の合理化及び管理の適正化に関する法律 (フロン排出抑制法)」に従って行うこと。<br>また、法に規定するものの他、次の書類を監督職員に提出すること。<br>(ア) 第一種フロン類充填回収業者登録通知書の写し<br>(イ) フロン類の処理に関する証明書 (充填証明書、引取証明書等)<br>(2) 行程管理票の様式は、監督職員の指示による。<br>2 家庭用エアコンの処分 家庭用のエアコン等で「特定家庭用機器再商品化法 (家電リサイクル法)」の対象となっているものは、本工事では撤去までとし、処分等については、施設管理者へ引き渡しを行う。<br>3 吸収冷凍機、吸収冷温水機等の美化リチウム水溶液等 ※ 無 ・ 有<br>関係法令に従い、専門業者により適正に処理すること。<br>4 石綿含有建材の除去工事 事前調査 ※ 行う ・ 行わない<br>工事着手に先立ち、目視及び貸与する設計図書等により石綿を含有している建築材料等の使用の有無について調査する。<br>分析による石綿含有建材の調査 ※ 行わない ・ 行う ( 箇所 )<br>測定箇所等は監督職員の指示による。<br>石綿粉じん濃度測定 ※ 行わない ・ 行う ( 箇所 )<br>測定箇所等は監督職員の指示による。<br>石綿作業主任者 石綿作業主任者技能講習修了者又は平成18年3月以前の特定化学物質作業主任者の有資格者の内から選任し、法令に基づき、作業の方法、労働者の指導等必要な措置を行うこと。<br>石綿含有品 ・ フランジ用ガasket ( ・ 配管 ・ ダクト )<br>・ 配管成形保温材<br>・ 天井材<br>・ 外壁 ( ・ 塗材 ・ スレート ・ )<br>撤去部にアスベストを含む材料が使用されている場合は、適切に処理を行い、必要に応じて官公庁等への届出を行うこと。<br>石綿含有塗材の塗布された外壁及び石綿含有スレート 波板等の外壁面に対して、足場及び配管等の支持のため、アンカーを打設する際にも、石綿作業主任者を配置し、外壁面に対して湿潤状態とし、集塵機付き電動工具を使用する等、飛散防止措置を講ずること。 | <p>別表 1</p> <table border="1"> <tr><th>名</th><th>称</th></tr> <tr><td>◎</td><td>配管類</td></tr> <tr><td>◎</td><td>給水管</td></tr> <tr><td>◎</td><td>排水管</td></tr> <tr><td>◎</td><td>冷温水管</td></tr> <tr><td>◎</td><td>冷煤管</td></tr> <tr><td>・</td><td>弁類</td></tr> <tr><td>◎</td><td>仕切弁</td></tr> <tr><td>・</td><td>バタフライ弁</td></tr> <tr><td>◎</td><td>逆止弁</td></tr> <tr><td>◎</td><td>緊急遮断弁</td></tr> <tr><td>・</td><td>ポンプ類</td></tr> <tr><td>◎</td><td>給水用ポンプ</td></tr> <tr><td>・</td><td>空調用ポンプ</td></tr> <tr><td>・</td><td>消火ポンプ</td></tr> <tr><td>・</td><td>タンク類</td></tr> <tr><td>◎</td><td>受水槽</td></tr> <tr><td>・</td><td>高架水槽</td></tr> <tr><td>・</td><td>貯湯槽</td></tr> <tr><td>・</td><td>膨張水槽</td></tr> <tr><td>・</td><td>空気調和設備工事用機材</td></tr> <tr><td>◎</td><td>パッケージエアコン</td></tr> <tr><td>・</td><td>空気調和機 (AHU)</td></tr> <tr><td>・</td><td>冷却塔</td></tr> <tr><td>・</td><td>ヘッダー</td></tr> <tr><td>・</td><td>自動制御機器類</td></tr> <tr><td>・</td><td>中央監視盤</td></tr> <tr><td>・</td><td>リモート盤</td></tr> <tr><td>・</td><td>給排水衛生設備工事用機材</td></tr> <tr><td>◎</td><td>衛生器具</td></tr> <tr><td>◎</td><td>水栓</td></tr> <tr><td>◎</td><td>組立てマンホール</td></tr> <tr><td>・</td><td>浄化槽</td></tr> <tr><td>・</td><td>F R P 浄化槽</td></tr> <tr><td>・</td><td>動力盤、制御盤</td></tr> <tr><td>・</td><td>プロワー</td></tr> <tr><td>・</td><td>さく井</td></tr> <tr><td>・</td><td>スクリーン</td></tr> <tr><td>・</td><td>その他</td></tr> <tr><td>◎</td><td>スリーブ (つば付鋼管)</td></tr> <tr><td>・</td><td>◎ 印の付いたものを適用する。</td></tr> </table> | 名   | 称   | ◎ | 配管類 | ◎   | 給水管 | ◎   | 排水管 | ◎   | 冷温水管 | ◎    | 冷煤管 | ・   | 弁類 | ◎  | 仕切弁 | ・   | バタフライ弁 | ◎      | 逆止弁 | ◎   | 緊急遮断弁 | ・     | ポンプ類 | ◎    | 給水用ポンプ | ・      | 空調用ポンプ | ・      | 消火ポンプ | ・     | タンク類 | ◎    | 受水槽 | ・   | 高架水槽 | ・    | 貯湯槽 | ・   | 膨張水槽 | ・    | 空気調和設備工事用機材 | ◎           | パッケージエアコン | ・         | 空気調和機 (AHU) | ・           | 冷却塔 | ・   | ヘッダー | ・    | 自動制御機器類 | ・       | 中央監視盤 | ・     | リモート盤 | ・     | 給排水衛生設備工事用機材 | ◎            | 衛生器具 | ◎    | 水栓 | ◎  | 組立てマンホール | ・        | 浄化槽 | ・   | F R P 浄化槽 | ・         | 動力盤、制御盤 | ・       | プロワー | ・    | さく井 | ・   | スクリーン | ・     | その他 | ◎   | スリーブ (つば付鋼管) | ・            | ◎ 印の付いたものを適用する。 |                 |
| 名             | 称   |          |   |   |   |   |   |     |     |     |     |     |     |      |      |     |     |    |    |     |     |        |        |     |     |       |       |      |      |        |        |        |        |       |       |      |      |     |     |      |      |     |     |      |      |             |             |           |           |             |             |     |     |      |      |         |         |       |       |       |       |              |              |      |      |    |    |          |          |     |     |           |           |         |         |      |      |     |     |       |       |     |     |              |              |                 |                 |
| ◎             | 配管類   |          |   |   |   |   |   |     |     |     |     |     |     |      |      |     |     |    |    |     |     |        |        |     |     |       |       |      |      |        |        |        |        |       |       |      |      |     |     |      |      |     |     |      |      |             |             |           |           |             |             |     |     |      |      |         |         |       |       |       |       |              |              |      |      |    |    |          |          |     |     |           |           |         |         |      |      |     |     |       |       |     |     |              |              |                 |                 |
| ◎             | 給水管   |          |   |   |   |   |   |     |     |     |     |     |     |      |      |     |     |    |    |     |     |        |        |     |     |       |       |      |      |        |        |        |        |       |       |      |      |     |     |      |      |     |     |      |      |             |             |           |           |             |             |     |     |      |      |         |         |       |       |       |       |              |              |      |      |    |    |          |          |     |     |           |           |         |         |      |      |     |     |       |       |     |     |              |              |                 |                 |
| ◎             | 排水管   |          |   |   |   |   |   |     |     |     |     |     |     |      |      |     |     |    |    |     |     |        |        |     |     |       |       |      |      |        |        |        |        |       |       |      |      |     |     |      |      |     |     |      |      |             |             |           |           |             |             |     |     |      |      |         |         |       |       |       |       |              |              |      |      |    |    |          |          |     |     |           |           |         |         |      |      |     |     |       |       |     |     |              |              |                 |                 |
| ◎             | 冷温水管  |          |   |   |   |   |   |     |     |     |     |     |     |      |      |     |     |    |    |     |     |        |        |     |     |       |       |      |      |        |        |        |        |       |       |      |      |     |     |      |      |     |     |      |      |             |             |           |           |             |             |     |     |      |      |         |         |       |       |       |       |              |              |      |      |    |    |          |          |     |     |           |           |         |         |      |      |     |     |       |       |     |     |              |              |                 |                 |
| ◎             | 冷煤管   |          |   |   |   |   |   |     |     |     |     |     |     |      |      |     |     |    |    |     |     |        |        |     |     |       |       |      |      |        |        |        |        |       |       |      |      |     |     |      |      |     |     |      |      |             |             |           |           |             |             |     |     |      |      |         |         |       |       |       |       |              |              |      |      |    |    |          |          |     |     |           |           |         |         |      |      |     |     |       |       |     |     |              |              |                 |                 |
| ・             | 弁類  |          |   |   |   |   |   |     |     |     |     |     |     |      |      |     |     |    |    |     |     |        |        |     |     |       |       |      |      |        |        |        |        |       |       |      |      |     |     |      |      |     |     |      |      |             |             |           |           |             |             |     |     |      |      |         |         |       |       |       |       |              |              |      |      |    |    |          |          |     |     |           |           |         |         |      |      |     |     |       |       |     |     |              |              |                 |                 |
| ◎             | 仕切弁   |          |   |   |   |   |   |     |     |     |     |     |     |      |      |     |     |    |    |     |     |        |        |     |     |       |       |      |      |        |        |        |        |       |       |      |      |     |     |      |      |     |     |      |      |             |             |           |           |             |             |     |     |      |      |         |         |       |       |       |       |              |              |      |      |    |    |          |          |     |     |           |           |         |         |      |      |     |     |       |       |     |     |              |              |                 |                 |
| ・             | バタフライ弁  |          |   |   |   |   |   |     |     |     |     |     |     |      |      |     |     |    |    |     |     |        |        |     |     |       |       |      |      |        |        |        |        |       |       |      |      |     |     |      |      |     |     |      |      |             |             |           |           |             |             |     |     |      |      |         |         |       |       |       |       |              |              |      |      |    |    |          |          |     |     |           |           |         |         |      |      |     |     |       |       |     |     |              |              |                 |                 |
| ◎             | 逆止弁   |          |   |   |   |   |   |     |     |     |     |     |     |      |      |     |     |    |    |     |     |        |        |     |     |       |       |      |      |        |        |        |        |       |       |      |      |     |     |      |      |     |     |      |      |             |             |           |           |             |             |     |     |      |      |         |         |       |       |       |       |              |              |      |      |    |    |          |          |     |     |           |           |         |         |      |      |     |     |       |       |     |     |              |              |                 |                 |
| ◎             | 緊急遮断弁   |          |   |   |   |   |   |     |     |     |     |     |     |      |      |     |     |    |    |     |     |        |        |     |     |       |       |      |      |        |        |        |        |       |       |      |      |     |     |      |      |     |     |      |      |             |             |           |           |             |             |     |     |      |      |         |         |       |       |       |       |              |              |      |      |    |    |          |          |     |     |           |           |         |         |      |      |     |     |       |       |     |     |              |              |                 |                 |
| ・             | ポンプ類  |          |   |   |   |   |   |     |     |     |     |     |     |      |      |     |     |    |    |     |     |        |        |     |     |       |       |      |      |        |        |        |        |       |       |      |      |     |     |      |      |     |     |      |      |             |             |           |           |             |             |     |     |      |      |         |         |       |       |       |       |              |              |      |      |    |    |          |          |     |     |           |           |         |         |      |      |     |     |       |       |     |     |              |              |                 |                 |
| ◎             | 給水用ポンプ  |          |   |   |   |   |   |     |     |     |     |     |     |      |      |     |     |    |    |     |     |        |        |     |     |       |       |      |      |        |        |        |        |       |       |      |      |     |     |      |      |     |     |      |      |             |             |           |           |             |             |     |     |      |      |         |         |       |       |       |       |              |              |      |      |    |    |          |          |     |     |           |           |         |         |      |      |     |     |       |       |     |     |              |              |                 |                 |
| ・             | 空調用ポンプ  |          |   |   |   |   |   |     |     |     |     |     |     |      |      |     |     |    |    |     |     |        |        |     |     |       |       |      |      |        |        |        |        |       |       |      |      |     |     |      |      |     |     |      |      |             |             |           |           |             |             |     |     |      |      |         |         |       |       |       |       |              |              |      |      |    |    |          |          |     |     |           |           |         |         |      |      |     |     |       |       |     |     |              |              |                 |                 |
| ・             | 消火ポンプ   |          |   |   |   |   |   |     |     |     |     |     |     |      |      |     |     |    |    |     |     |        |        |     |     |       |       |      |      |        |        |        |        |       |       |      |      |     |     |      |      |     |     |      |      |             |             |           |           |             |             |     |     |      |      |         |         |       |       |       |       |              |              |      |      |    |    |          |          |     |     |           |           |         |         |      |      |     |     |       |       |     |     |              |              |                 |                 |
| ・             | タンク類  |          |   |   |   |   |   |     |     |     |     |     |     |      |      |     |     |    |    |     |     |        |        |     |     |       |       |      |      |        |        |        |        |       |       |      |      |     |     |      |      |     |     |      |      |             |             |           |           |             |             |     |     |      |      |         |         |       |       |       |       |              |              |      |      |    |    |          |          |     |     |           |           |         |         |      |      |     |     |       |       |     |     |              |              |                 |                 |
| ◎             | 受水槽   |          |   |   |   |   |   |     |     |     |     |     |     |      |      |     |     |    |    |     |     |        |        |     |     |       |       |      |      |        |        |        |        |       |       |      |      |     |     |      |      |     |     |      |      |             |             |           |           |             |             |     |     |      |      |         |         |       |       |       |       |              |              |      |      |    |    |          |          |     |     |           |           |         |         |      |      |     |     |       |       |     |     |              |              |                 |                 |
| ・             | 高架水槽  |          |   |   |   |   |   |     |     |     |     |     |     |      |      |     |     |    |    |     |     |        |        |     |     |       |       |      |      |        |        |        |        |       |       |      |      |     |     |      |      |     |     |      |      |             |             |           |           |             |             |     |     |      |      |         |         |       |       |       |       |              |              |      |      |    |    |          |          |     |     |           |           |         |         |      |      |     |     |       |       |     |     |              |              |                 |                 |
| ・             | 貯湯槽   |          |   |   |   |   |   |     |     |     |     |     |     |      |      |     |     |    |    |     |     |        |        |     |     |       |       |      |      |        |        |        |        |       |       |      |      |     |     |      |      |     |     |      |      |             |             |           |           |             |             |     |     |      |      |         |         |       |       |       |       |              |              |      |      |    |    |          |          |     |     |           |           |         |         |      |      |     |     |       |       |     |     |              |              |                 |                 |
| ・             | 膨張水槽  |          |   |   |   |   |   |     |     |     |     |     |     |      |      |     |     |    |    |     |     |        |        |     |     |       |       |      |      |        |        |        |        |       |       |      |      |     |     |      |      |     |     |      |      |             |             |           |           |             |             |     |     |      |      |         |         |       |       |       |       |              |              |      |      |    |    |          |          |     |     |           |           |         |         |      |      |     |     |       |       |     |     |              |              |                 |                 |
| ・             | 空気調和設備工事用機材   |          |   |   |   |   |   |     |     |     |     |     |     |      |      |     |     |    |    |     |     |        |        |     |     |       |       |      |      |        |        |        |        |       |       |      |      |     |     |      |      |     |     |      |      |             |             |           |           |             |             |     |     |      |      |         |         |       |       |       |       |              |              |      |      |    |    |          |          |     |     |           |           |         |         |      |      |     |     |       |       |     |     |              |              |                 |                 |
| ◎             | パッケージエアコン   |          |   |   |   |   |   |     |     |     |     |     |     |      |      |     |     |    |    |     |     |        |        |     |     |       |       |      |      |        |        |        |        |       |       |      |      |     |     |      |      |     |     |      |      |             |             |           |           |             |             |     |     |      |      |         |         |       |       |       |       |              |              |      |      |    |    |          |          |     |     |           |           |         |         |      |      |     |     |       |       |     |     |              |              |                 |                 |
| ・             | 空気調和機 (AHU)   |          |   |   |   |   |   |     |     |     |     |     |     |      |      |     |     |    |    |     |     |        |        |     |     |       |       |      |      |        |        |        |        |       |       |      |      |     |     |      |      |     |     |      |      |             |             |           |           |             |             |     |     |      |      |         |         |       |       |       |       |              |              |      |      |    |    |          |          |     |     |           |           |         |         |      |      |     |     |       |       |     |     |              |              |                 |                 |
| ・             | 冷却塔   |          |   |   |   |   |   |     |     |     |     |     |     |      |      |     |     |    |    |     |     |        |        |     |     |       |       |      |      |        |        |        |        |       |       |      |      |     |     |      |      |     |     |      |      |             |             |           |           |             |             |     |     |      |      |         |         |       |       |       |       |              |              |      |      |    |    |          |          |     |     |           |           |         |         |      |      |     |     |       |       |     |     |              |              |                 |                 |
| ・             | ヘッダー  |          |   |   |   |   |   |     |     |     |     |     |     |      |      |     |     |    |    |     |     |        |        |     |     |       |       |      |      |        |        |        |        |       |       |      |      |     |     |      |      |     |     |      |      |             |             |           |           |             |             |     |     |      |      |         |         |       |       |       |       |              |              |      |      |    |    |          |          |     |     |           |           |         |         |      |      |     |     |       |       |     |     |              |              |                 |                 |
| ・             | 自動制御機器類   |          |   |   |   |   |   |     |     |     |     |     |     |      |      |     |     |    |    |     |     |        |        |     |     |       |       |      |      |        |        |        |        |       |       |      |      |     |     |      |      |     |     |      |      |             |             |           |           |             |             |     |     |      |      |         |         |       |       |       |       |              |              |      |      |    |    |          |          |     |     |           |           |         |         |      |      |     |     |       |       |     |     |              |              |                 |                 |
| ・             | 中央監視盤   |          |   |   |   |   |   |     |     |     |     |     |     |      |      |     |     |    |    |     |     |        |        |     |     |       |       |      |      |        |        |        |        |       |       |      |      |     |     |      |      |     |     |      |      |             |             |           |           |             |             |     |     |      |      |         |         |       |       |       |       |              |              |      |      |    |    |          |          |     |     |           |           |         |         |      |      |     |     |       |       |     |     |              |              |                 |                 |
| ・             | リモート盤   |          |   |   |   |   |   |     |     |     |     |     |     |      |      |     |     |    |    |     |     |        |        |     |     |       |       |      |      |        |        |        |        |       |       |      |      |     |     |      |      |     |     |      |      |             |             |           |           |             |             |     |     |      |      |         |         |       |       |       |       |              |              |      |      |    |    |          |          |     |     |           |           |         |         |      |      |     |     |       |       |     |     |              |              |                 |                 |
| ・             | 給排水衛生設備工事用機材  |          |   |   |   |   |   |     |     |     |     |     |     |      |      |     |     |    |    |     |     |        |        |     |     |       |       |      |      |        |        |        |        |       |       |      |      |     |     |      |      |     |     |      |      |             |             |           |           |             |             |     |     |      |      |         |         |       |       |       |       |              |              |      |      |    |    |          |          |     |     |           |           |         |         |      |      |     |     |       |       |     |     |              |              |                 |                 |
| ◎             | 衛生器具  |          |   |   |   |   |   |     |     |     |     |     |     |      |      |     |     |    |    |     |     |        |        |     |     |       |       |      |      |        |        |        |        |       |       |      |      |     |     |      |      |     |     |      |      |             |             |           |           |             |             |     |     |      |      |         |         |       |       |       |       |              |              |      |      |    |    |          |          |     |     |           |           |         |         |      |      |     |     |       |       |     |     |              |              |                 |                 |
| ◎             | 水栓  |          |   |   |   |   |   |     |     |     |     |     |     |      |      |     |     |    |    |     |     |        |        |     |     |       |       |      |      |        |        |        |        |       |       |      |      |     |     |      |      |     |     |      |      |             |             |           |           |             |             |     |     |      |      |         |         |       |       |       |       |              |              |      |      |    |    |          |          |     |     |           |           |         |         |      |      |     |     |       |       |     |     |              |              |                 |                 |
| ◎             | 組立てマンホール  |          |   |   |   |   |   |     |     |     |     |     |     |      |      |     |     |    |    |     |     |        |        |     |     |       |       |      |      |        |        |        |        |       |       |      |      |     |     |      |      |     |     |      |      |             |             |           |           |             |             |     |     |      |      |         |         |       |       |       |       |              |              |      |      |    |    |          |          |     |     |           |           |         |         |      |      |     |     |       |       |     |     |              |              |                 |                 |
| ・             | 浄化槽   |          |   |   |   |   |   |     |     |     |     |     |     |      |      |     |     |    |    |     |     |        |        |     |     |       |       |      |      |        |        |        |        |       |       |      |      |     |     |      |      |     |     |      |      |             |             |           |           |             |             |     |     |      |      |         |         |       |       |       |       |              |              |      |      |    |    |          |          |     |     |           |           |         |         |      |      |     |     |       |       |     |     |              |              |                 |                 |
| ・             | F R P 浄化槽   |          |   |   |   |   |   |     |     |     |     |     |     |      |      |     |     |    |    |     |     |        |        |     |     |       |       |      |      |        |        |        |        |       |       |      |      |     |     |      |      |     |     |      |      |             |             |           |           |             |             |     |     |      |      |         |         |       |       |       |       |              |              |      |      |    |    |          |          |     |     |           |           |         |         |      |      |     |     |       |       |     |     |              |              |                 |                 |
| ・             | 動力盤、制御盤   |          |   |   |   |   |   |     |     |     |     |     |     |      |      |     |     |    |    |     |     |        |        |     |     |       |       |      |      |        |        |        |        |       |       |      |      |     |     |      |      |     |     |      |      |             |             |           |           |             |             |     |     |      |      |         |         |       |       |       |       |              |              |      |      |    |    |          |          |     |     |           |           |         |         |      |      |     |     |       |       |     |     |              |              |                 |                 |
| ・             | プロワー  |          |   |   |   |   |   |     |     |     |     |     |     |      |      |     |     |    |    |     |     |        |        |     |     |       |       |      |      |        |        |        |        |       |       |      |      |     |     |      |      |     |     |      |      |             |             |           |           |             |             |     |     |      |      |         |         |       |       |       |       |              |              |      |      |    |    |          |          |     |     |           |           |         |         |      |      |     |     |       |       |     |     |              |              |                 |                 |
| ・             | さく井   |          |   |   |   |   |   |     |     |     |     |     |     |      |      |     |     |    |    |     |     |        |        |     |     |       |       |      |      |        |        |        |        |       |       |      |      |     |     |      |      |     |     |      |      |             |             |           |           |             |             |     |     |      |      |         |         |       |       |       |       |              |              |      |      |    |    |          |          |     |     |           |           |         |         |      |      |     |     |       |       |     |     |              |              |                 |                 |
| ・             | スクリーン   |          |   |   |   |   |   |     |     |     |     |     |     |      |      |     |     |    |    |     |     |        |        |     |     |       |       |      |      |        |        |        |        |       |       |      |      |     |     |      |      |     |     |      |      |             |             |           |           |             |             |     |     |      |      |         |         |       |       |       |       |              |              |      |      |    |    |          |          |     |     |           |           |         |         |      |      |     |     |       |       |     |     |              |              |                 |                 |
| ・             | その他   |          |   |   |   |   |   |     |     |     |     |     |     |      |      |     |     |    |    |     |     |        |        |     |     |       |       |      |      |        |        |        |        |       |       |      |      |     |     |      |      |     |     |      |      |             |             |           |           |             |             |     |     |      |      |         |         |       |       |       |       |              |              |      |      |    |    |          |          |     |     |           |           |         |         |      |      |     |     |       |       |     |     |              |              |                 |                 |
| ◎             | スリーブ (つば付鋼管)  |          |   |   |   |   |   |     |     |     |     |     |     |      |      |     |     |    |    |     |     |        |        |     |     |       |       |      |      |        |        |        |        |       |       |      |      |     |     |      |      |     |     |      |      |             |             |           |           |             |             |     |     |      |      |         |         |       |       |       |       |              |              |      |      |    |    |          |          |     |     |           |           |         |         |      |      |     |     |       |       |     |     |              |              |                 |                 |
| ・             | ◎ 印の付いたものを適用する。   |          |   |   |   |   |   |     |     |     |     |     |     |      |      |     |     |    |    |     |     |        |        |     |     |       |       |      |      |        |        |        |        |       |       |      |      |     |     |      |      |     |     |      |      |             |             |           |           |             |             |     |     |      |      |         |         |       |       |       |       |              |              |      |      |    |    |          |          |     |     |           |           |         |         |      |      |     |     |       |       |     |     |              |              |                 |                 |
| 屋内排水設備        | 1 配管材料 雑排水 ※ 排水用硬質塩化ビニルライニング鋼管<br>・ リサイクル硬質ポリ塩化ビニル発泡三層管 (RF-VP)<br>・ 硬質塩化ビニル管 (VP)<br>・ 配管用炭素鋼鋼管 (白)<br>◎ 図示による<br>汚水 ※ 排水用硬質塩化ビニルライニング鋼管<br>・ リサイクル硬質ポリ塩化ビニル発泡三層管 (RF-VP)<br>・ 硬質塩化ビニル管 (VP)<br>◎ 図示による<br>通気 ※ 配管用炭素鋼鋼管 (白)<br>・ リサイクル硬質ポリ塩化ビニル発泡三層管 (RF-VP)<br>・ 硬質塩化ビニル管 (VP)<br>◎ 図示による<br>2 配管施工 (1) 排水横主管に設ける90° 曲管は原則として大曲管とする。<br>(2) 排水縦管の下部曲がり管及び排水横枝管の水平曲がり管は大曲管とする。<br>3 試験 満水試験 ・ 行わない ※ 行う<br>煙試験 ※ 行わない ・ 行う<br>排水の通水試験は、樹への放流を確認し、報告書を作成すること。<br>(空調ドレン排水を含む)<br>4 その他 流しの床上部分の配管を硬質塩化ビニル管 (VP) とする場合は監督職員と協議する。(フレキシブルジョイントによる接続は不可)<br>耐火二層管は国土交通大臣認定及び (一財) 日本消防設備安全センター性能評定に基づき、伸縮継手を設置すること。 | 撤去工事     | 1 冷媒 (フロン系) の回収 ※ 無 ・ 有<br>(1) 冷媒の回収にあたっては、「フロン類の使用の合理化及び管理の適正化に関する法律 (フロン排出抑制法)」に従って行うこと。<br>また、法に規定するものの他、次の書類を監督職員に提出すること。<br>(ア) 第一種フロン類充填回収業者登録通知書の写し<br>(イ) フロン類の処理に関する証明書 (充填証明書、引取証明書等)<br>(2) 行程管理票の様式は、監督職員の指示による。<br>2 家庭用エアコンの処分 家庭用のエアコン等で「特定家庭用機器再商品化法 (家電リサイクル法)」の対象となっているものは、本工事では撤去までとし、処分等については、施設管理者へ引き渡しを行う。<br>3 吸収冷凍機、吸収冷温水機等の美化リチウム水溶液等 ※ 無 ・ 有<br>関係法令に従い、専門業者により適正に処理すること。<br>4 石綿含有建材の除去工事 事前調査 ※ 行う ・ 行わない<br>工事着手に先立ち、目視及び貸与する設計図書等により石綿を含有している建築材料等の使用の有無について調査する。<br>分析による石綿含有建材の調査 ※ 行わない ・ 行う ( 箇所 )<br>測定箇所等は監督職員の指示による。<br>石綿粉じん濃度測定 ※ 行わない ・ 行う ( 箇所 )<br>測定箇所等は監督職員の指示による。<br>石綿作業主任者 石綿作業主任者技能講習修了者又は平成18年3月以前の特定化学物質作業主任者の有資格者の内から選任し、法令に基づき、作業の方法、労働者の指導等必要な措置を行うこと。<br>石綿含有品 ・ フランジ用ガasket ( ・ 配管 ・ ダクト )<br>・ 配管成形保温材<br>・ 天井材<br>・ 外壁 ( ・ 塗材 ・ スレート ・ )<br>撤去部にアスベストを含む材料が使用されている場合は、適切に処理を行い、必要に応じて官公庁等への届出を行うこと。<br>石綿含有塗材の塗布された外壁及び石綿含有スレート 波板等の外壁面に対して、足場及び配管等の支持のため、アンカーを打設する際にも、石綿作業主任者を配置し、外壁面に対して湿潤状態とし、集塵機付き電動工具を使用する等、飛散防止措置を講ずること。 | <p>別表 1</p> <table border="1"> <tr><th>名</th><th>称</th></tr> <tr><td>◎</td><td>配管類</td></tr> <tr><td>◎</td><td>給水管</td></tr> <tr><td>◎</td><td>排水管</td></tr> <tr><td>◎</td><td>冷温水管</td></tr> <tr><td>◎</td><td>冷煤管</td></tr> <tr><td>・</td><td>弁類</td></tr> <tr><td>◎</td><td>仕切弁</td></tr> <tr><td>・</td><td>バタフライ弁</td></tr> <tr><td>◎</td><td>逆止弁</td></tr> <tr><td>◎</td><td>緊急遮断弁</td></tr> <tr><td>・</td><td>ポンプ類</td></tr> <tr><td>◎</td><td>給水用ポンプ</td></tr> <tr><td>・</td><td>空調用ポンプ</td></tr> <tr><td>・</td><td>消火ポンプ</td></tr> <tr><td>・</td><td>タンク類</td></tr> <tr><td>◎</td><td>受水槽</td></tr> <tr><td>・</td><td>高架水槽</td></tr> <tr><td>・</td><td>貯湯槽</td></tr> <tr><td>・</td><td>膨張水槽</td></tr> <tr><td>・</td><td>空気調和設備工事用機材</td></tr> <tr><td>◎</td><td>パッケージエアコン</td></tr> <tr><td>・</td><td>空気調和機 (AHU)</td></tr> <tr><td>・</td><td>冷却塔</td></tr> <tr><td>・</td><td>ヘッダー</td></tr> <tr><td>・</td><td>自動制御機器類</td></tr> <tr><td>・</td><td>中央監視盤</td></tr> <tr><td>・</td><td>リモート盤</td></tr> <tr><td>・</td><td>給排水衛生設備工事用機材</td></tr> <tr><td>◎</td><td>衛生器具</td></tr> <tr><td>◎</td><td>水栓</td></tr> <tr><td>◎</td><td>組立てマンホール</td></tr> <tr><td>・</td><td>浄化槽</td></tr> <tr><td>・</td><td>F R P 浄化槽</td></tr> <tr><td>・</td><td>動力盤、制御盤</td></tr> <tr><td>・</td><td>プロワー</td></tr> <tr><td>・</td><td>さく井</td></tr> <tr><td>・</td><td>スクリーン</td></tr> <tr><td>・</td><td>その他</td></tr> <tr><td>◎</td><td>スリーブ (つば付鋼管)</td></tr> <tr><td>・</td><td>◎ 印の付いたものを適用する。</td></tr> </table> | 名   | 称   | ◎ | 配管類 | ◎   | 給水管 | ◎   | 排水管 | ◎   | 冷温水管 | ◎    | 冷煤管 | ・   | 弁類 | ◎  | 仕切弁 | ・   | バタフライ弁 | ◎      | 逆止弁 | ◎   | 緊急遮断弁 | ・     | ポンプ類 | ◎    | 給水用ポンプ | ・      | 空調用ポンプ | ・      | 消火ポンプ | ・     | タンク類 | ◎    | 受水槽 | ・   | 高架水槽 | ・    | 貯湯槽 | ・   | 膨張水槽 | ・    | 空気調和設備工事用機材 | ◎           | パッケージエアコン | ・         | 空気調和機 (AHU) | ・           | 冷却塔 | ・   | ヘッダー | ・    | 自動制御機器類 | ・       | 中央監視盤 | ・     | リモート盤 | ・     | 給排水衛生設備工事用機材 | ◎            | 衛生器具 | ◎    | 水栓 | ◎  | 組立てマンホール | ・        | 浄化槽 | ・   | F R P 浄化槽 | ・         | 動力盤、制御盤 | ・       | プロワー | ・    | さく井 | ・   | スクリーン | ・     | その他 | ◎   | スリーブ (つば付鋼管) | ・            | ◎ 印の付いたものを適用する。 |                 |
| 名             | 称   |          |   |   |   |   |   |     |     |     |     |     |     |      |      |     |     |    |    |     |     |        |        |     |     |       |       |      |      |        |        |        |        |       |       |      |      |     |     |      |      |     |     |      |      |             |             |           |           |             |             |     |     |      |      |         |         |       |       |       |       |              |              |      |      |    |    |          |          |     |     |           |           |         |         |      |      |     |     |       |       |     |     |              |              |                 |                 |
| ◎             | 配管類   |          |   |   |   |   |   |     |     |     |     |     |     |      |      |     |     |    |    |     |     |        |        |     |     |       |       |      |      |        |        |        |        |       |       |      |      |     |     |      |      |     |     |      |      |             |             |           |           |             |             |     |     |      |      |         |         |       |       |       |       |              |              |      |      |    |    |          |          |     |     |           |           |         |         |      |      |     |     |       |       |     |     |              |              |                 |                 |
| ◎             | 給水管   |          |   |   |   |   |   |     |     |     |     |     |     |      |      |     |     |    |    |     |     |        |        |     |     |       |       |      |      |        |        |        |        |       |       |      |      |     |     |      |      |     |     |      |      |             |             |           |           |             |             |     |     |      |      |         |         |       |       |       |       |              |              |      |      |    |    |          |          |     |     |           |           |         |         |      |      |     |     |       |       |     |     |              |              |                 |                 |
| ◎             | 排水管   |          |   |   |   |   |   |     |     |     |     |     |     |      |      |     |     |    |    |     |     |        |        |     |     |       |       |      |      |        |        |        |        |       |       |      |      |     |     |      |      |     |     |      |      |             |             |           |           |             |             |     |     |      |      |         |         |       |       |       |       |              |              |      |      |    |    |          |          |     |     |           |           |         |         |      |      |     |     |       |       |     |     |              |              |                 |                 |
| ◎             | 冷温水管  |          |   |   |   |   |   |     |     |     |     |     |     |      |      |     |     |    |    |     |     |        |        |     |     |       |       |      |      |        |        |        |        |       |       |      |      |     |     |      |      |     |     |      |      |             |             |           |           |             |             |     |     |      |      |         |         |       |       |       |       |              |              |      |      |    |    |          |          |     |     |           |           |         |         |      |      |     |     |       |       |     |     |              |              |                 |                 |
| ◎             | 冷煤管   |          |   |   |   |   |   |     |     |     |     |     |     |      |      |     |     |    |    |     |     |        |        |     |     |       |       |      |      |        |        |        |        |       |       |      |      |     |     |      |      |     |     |      |      |             |             |           |           |             |             |     |     |      |      |         |         |       |       |       |       |              |              |      |      |    |    |          |          |     |     |           |           |         |         |      |      |     |     |       |       |     |     |              |              |                 |                 |
| ・             | 弁類  |          |   |   |   |   |   |     |     |     |     |     |     |      |      |     |     |    |    |     |     |        |        |     |     |       |       |      |      |        |        |        |        |       |       |      |      |     |     |      |      |     |     |      |      |             |             |           |           |             |             |     |     |      |      |         |         |       |       |       |       |              |              |      |      |    |    |          |          |     |     |           |           |         |         |      |      |     |     |       |       |     |     |              |              |                 |                 |
| ◎             | 仕切弁   |          |   |   |   |   |   |     |     |     |     |     |     |      |      |     |     |    |    |     |     |        |        |     |     |       |       |      |      |        |        |        |        |       |       |      |      |     |     |      |      |     |     |      |      |             |             |           |           |             |             |     |     |      |      |         |         |       |       |       |       |              |              |      |      |    |    |          |          |     |     |           |           |         |         |      |      |     |     |       |       |     |     |              |              |                 |                 |
| ・             | バタフライ弁  |          |   |   |   |   |   |     |     |     |     |     |     |      |      |     |     |    |    |     |     |        |        |     |     |       |       |      |      |        |        |        |        |       |       |      |      |     |     |      |      |     |     |      |      |             |             |           |           |             |             |     |     |      |      |         |         |       |       |       |       |              |              |      |      |    |    |          |          |     |     |           |           |         |         |      |      |     |     |       |       |     |     |              |              |                 |                 |
| ◎             | 逆止弁   |          |   |   |   |   |   |     |     |     |     |     |     |      |      |     |     |    |    |     |     |        |        |     |     |       |       |      |      |        |        |        |        |       |       |      |      |     |     |      |      |     |     |      |      |             |             |           |           |             |             |     |     |      |      |         |         |       |       |       |       |              |              |      |      |    |    |          |          |     |     |           |           |         |         |      |      |     |     |       |       |     |     |              |              |                 |                 |
| ◎             | 緊急遮断弁   |          |   |   |   |   |   |     |     |     |     |     |     |      |      |     |     |    |    |     |     |        |        |     |     |       |       |      |      |        |        |        |        |       |       |      |      |     |     |      |      |     |     |      |      |             |             |           |           |             |             |     |     |      |      |         |         |       |       |       |       |              |              |      |      |    |    |          |          |     |     |           |           |         |         |      |      |     |     |       |       |     |     |              |              |                 |                 |
| ・             | ポンプ類  |          |   |   |   |   |   |     |     |     |     |     |     |      |      |     |     |    |    |     |     |        |        |     |     |       |       |      |      |        |        |        |        |       |       |      |      |     |     |      |      |     |     |      |      |             |             |           |           |             |             |     |     |      |      |         |         |       |       |       |       |              |              |      |      |    |    |          |          |     |     |           |           |         |         |      |      |     |     |       |       |     |     |              |              |                 |                 |
| ◎             | 給水用ポンプ  |          |   |   |   |   |   |     |     |     |     |     |     |      |      |     |     |    |    |     |     |        |        |     |     |       |       |      |      |        |        |        |        |       |       |      |      |     |     |      |      |     |     |      |      |             |             |           |           |             |             |     |     |      |      |         |         |       |       |       |       |              |              |      |      |    |    |          |          |     |     |           |           |         |         |      |      |     |     |       |       |     |     |              |              |                 |                 |
| ・             | 空調用ポンプ  |          |   |   |   |   |   |     |     |     |     |     |     |      |      |     |     |    |    |     |     |        |        |     |     |       |       |      |      |        |        |        |        |       |       |      |      |     |     |      |      |     |     |      |      |             |             |           |           |             |             |     |     |      |      |         |         |       |       |       |       |              |              |      |      |    |    |          |          |     |     |           |           |         |         |      |      |     |     |       |       |     |     |              |              |                 |                 |
| ・             | 消火ポンプ   |          |   |   |   |   |   |     |     |     |     |     |     |      |      |     |     |    |    |     |     |        |        |     |     |       |       |      |      |        |        |        |        |       |       |      |      |     |     |      |      |     |     |      |      |             |             |           |           |             |             |     |     |      |      |         |         |       |       |       |       |              |              |      |      |    |    |          |          |     |     |           |           |         |         |      |      |     |     |       |       |     |     |              |              |                 |                 |
| ・             | タンク類  |          |   |   |   |   |   |     |     |     |     |     |     |      |      |     |     |    |    |     |     |        |        |     |     |       |       |      |      |        |        |        |        |       |       |      |      |     |     |      |      |     |     |      |      |             |             |           |           |             |             |     |     |      |      |         |         |       |       |       |       |              |              |      |      |    |    |          |          |     |     |           |           |         |         |      |      |     |     |       |       |     |     |              |              |                 |                 |
| ◎             | 受水槽   |          |   |   |   |   |   |     |     |     |     |     |     |      |      |     |     |    |    |     |     |        |        |     |     |       |       |      |      |        |        |        |        |       |       |      |      |     |     |      |      |     |     |      |      |             |             |           |           |             |             |     |     |      |      |         |         |       |       |       |       |              |              |      |      |    |    |          |          |     |     |           |           |         |         |      |      |     |     |       |       |     |     |              |              |                 |                 |
| ・             | 高架水槽  |          |   |   |   |   |   |     |     |     |     |     |     |      |      |     |     |    |    |     |     |        |        |     |     |       |       |      |      |        |        |        |        |       |       |      |      |     |     |      |      |     |     |      |      |             |             |           |           |             |             |     |     |      |      |         |         |       |       |       |       |              |              |      |      |    |    |          |          |     |     |           |           |         |         |      |      |     |     |       |       |     |     |              |              |                 |                 |
| ・             | 貯湯槽   |          |   |   |   |   |   |     |     |     |     |     |     |      |      |     |     |    |    |     |     |        |        |     |     |       |       |      |      |        |        |        |        |       |       |      |      |     |     |      |      |     |     |      |      |             |             |           |           |             |             |     |     |      |      |         |         |       |       |       |       |              |              |      |      |    |    |          |          |     |     |           |           |         |         |      |      |     |     |       |       |     |     |              |              |                 |                 |
| ・             | 膨張水槽  |          |   |   |   |   |   |     |     |     |     |     |     |      |      |     |     |    |    |     |     |        |        |     |     |       |       |      |      |        |        |        |        |       |       |      |      |     |     |      |      |     |     |      |      |             |             |           |           |             |             |     |     |      |      |         |         |       |       |       |       |              |              |      |      |    |    |          |          |     |     |           |           |         |         |      |      |     |     |       |       |     |     |              |              |                 |                 |
| ・             | 空気調和設備工事用機材   |          |   |   |   |   |   |     |     |     |     |     |     |      |      |     |     |    |    |     |     |        |        |     |     |       |       |      |      |        |        |        |        |       |       |      |      |     |     |      |      |     |     |      |      |             |             |           |           |             |             |     |     |      |      |         |         |       |       |       |       |              |              |      |      |    |    |          |          |     |     |           |           |         |         |      |      |     |     |       |       |     |     |              |              |                 |                 |
| ◎             | パッケージエアコン   |          |   |   |   |   |   |     |     |     |     |     |     |      |      |     |     |    |    |     |     |        |        |     |     |       |       |      |      |        |        |        |        |       |       |      |      |     |     |      |      |     |     |      |      |             |             |           |           |             |             |     |     |      |      |         |         |       |       |       |       |              |              |      |      |    |    |          |          |     |     |           |           |         |         |      |      |     |     |       |       |     |     |              |              |                 |                 |
| ・             | 空気調和機 (AHU)   |          |   |   |   |   |   |     |     |     |     |     |     |      |      |     |     |    |    |     |     |        |        |     |     |       |       |      |      |        |        |        |        |       |       |      |      |     |     |      |      |     |     |      |      |             |             |           |           |             |             |     |     |      |      |         |         |       |       |       |       |              |              |      |      |    |    |          |          |     |     |           |           |         |         |      |      |     |     |       |       |     |     |              |              |                 |                 |
| ・             | 冷却塔   |          |   |   |   |   |   |     |     |     |     |     |     |      |      |     |     |    |    |     |     |        |        |     |     |       |       |      |      |        |        |        |        |       |       |      |      |     |     |      |      |     |     |      |      |             |             |           |           |             |             |     |     |      |      |         |         |       |       |       |       |              |              |      |      |    |    |          |          |     |     |           |           |         |         |      |      |     |     |       |       |     |     |              |              |                 |                 |
| ・             | ヘッダー  |          |   |   |   |   |   |     |     |     |     |     |     |      |      |     |     |    |    |     |     |        |        |     |     |       |       |      |      |        |        |        |        |       |       |      |      |     |     |      |      |     |     |      |      |             |             |           |           |             |             |     |     |      |      |         |         |       |       |       |       |              |              |      |      |    |    |          |          |     |     |           |           |         |         |      |      |     |     |       |       |     |     |              |              |                 |                 |
| ・             | 自動制御機器類   |          |   |   |   |   |   |     |     |     |     |     |     |      |      |     |     |    |    |     |     |        |        |     |     |       |       |      |      |        |        |        |        |       |       |      |      |     |     |      |      |     |     |      |      |             |             |           |           |             |             |     |     |      |      |         |         |       |       |       |       |              |              |      |      |    |    |          |          |     |     |           |           |         |         |      |      |     |     |       |       |     |     |              |              |                 |                 |
| ・             | 中央監視盤   |          |   |   |   |   |   |     |     |     |     |     |     |      |      |     |     |    |    |     |     |        |        |     |     |       |       |      |      |        |        |        |        |       |       |      |      |     |     |      |      |     |     |      |      |             |             |           |           |             |             |     |     |      |      |         |         |       |       |       |       |              |              |      |      |    |    |          |          |     |     |           |           |         |         |      |      |     |     |       |       |     |     |              |              |                 |                 |
| ・             | リモート盤   |          |   |   |   |   |   |     |     |     |     |     |     |      |      |     |     |    |    |     |     |        |        |     |     |       |       |      |      |        |        |        |        |       |       |      |      |     |     |      |      |     |     |      |      |             |             |           |           |             |             |     |     |      |      |         |         |       |       |       |       |              |              |      |      |    |    |          |          |     |     |           |           |         |         |      |      |     |     |       |       |     |     |              |              |                 |                 |
| ・             | 給排水衛生設備工事用機材  |          |   |   |   |   |   |     |     |     |     |     |     |      |      |     |     |    |    |     |     |        |        |     |     |       |       |      |      |        |        |        |        |       |       |      |      |     |     |      |      |     |     |      |      |             |             |           |           |             |             |     |     |      |      |         |         |       |       |       |       |              |              |      |      |    |    |          |          |     |     |           |           |         |         |      |      |     |     |       |       |     |     |              |              |                 |                 |
| ◎             | 衛生器具  |          |   |   |   |   |   |     |     |     |     |     |     |      |      |     |     |    |    |     |     |        |        |     |     |       |       |      |      |        |        |        |        |       |       |      |      |     |     |      |      |     |     |      |      |             |             |           |           |             |             |     |     |      |      |         |         |       |       |       |       |              |              |      |      |    |    |          |          |     |     |           |           |         |         |      |      |     |     |       |       |     |     |              |              |                 |                 |
| ◎             | 水栓  |          |   |   |   |   |   |     |     |     |     |     |     |      |      |     |     |    |    |     |     |        |        |     |     |       |       |      |      |        |        |        |        |       |       |      |      |     |     |      |      |     |     |      |      |             |             |           |           |             |             |     |     |      |      |         |         |       |       |       |       |              |              |      |      |    |    |          |          |     |     |           |           |         |         |      |      |     |     |       |       |     |     |              |              |                 |                 |
| ◎             | 組立てマンホール  |          |   |   |   |   |   |     |     |     |     |     |     |      |      |     |     |    |    |     |     |        |        |     |     |       |       |      |      |        |        |        |        |       |       |      |      |     |     |      |      |     |     |      |      |             |             |           |           |             |             |     |     |      |      |         |         |       |       |       |       |              |              |      |      |    |    |          |          |     |     |           |           |         |         |      |      |     |     |       |       |     |     |              |              |                 |                 |
| ・             | 浄化槽   |          |   |   |   |   |   |     |     |     |     |     |     |      |      |     |     |    |    |     |     |        |        |     |     |       |       |      |      |        |        |        |        |       |       |      |      |     |     |      |      |     |     |      |      |             |             |           |           |             |             |     |     |      |      |         |         |       |       |       |       |              |              |      |      |    |    |          |          |     |     |           |           |         |         |      |      |     |     |       |       |     |     |              |              |                 |                 |
| ・             | F R P 浄化槽   |          |   |   |   |   |   |     |     |     |     |     |     |      |      |     |     |    |    |     |     |        |        |     |     |       |       |      |      |        |        |        |        |       |       |      |      |     |     |      |      |     |     |      |      |             |             |           |           |             |             |     |     |      |      |         |         |       |       |       |       |              |              |      |      |    |    |          |          |     |     |           |           |         |         |      |      |     |     |       |       |     |     |              |              |                 |                 |
| ・             | 動力盤、制御盤   |          |   |   |   |   |   |     |     |     |     |     |     |      |      |     |     |    |    |     |     |        |        |     |     |       |       |      |      |        |        |        |        |       |       |      |      |     |     |      |      |     |     |      |      |             |             |           |           |             |             |     |     |      |      |         |         |       |       |       |       |              |              |      |      |    |    |          |          |     |     |           |           |         |         |      |      |     |     |       |       |     |     |              |              |                 |                 |
| ・             | プロワー  |          |   |   |   |   |   |     |     |     |     |     |     |      |      |     |     |    |    |     |     |        |        |     |     |       |       |      |      |        |        |        |        |       |       |      |      |     |     |      |      |     |     |      |      |             |             |           |           |             |             |     |     |      |      |         |         |       |       |       |       |              |              |      |      |    |    |          |          |     |     |           |           |         |         |      |      |     |     |       |       |     |     |              |              |                 |                 |
| ・             | さく井   |          |   |   |   |   |   |     |     |     |     |     |     |      |      |     |     |    |    |     |     |        |        |     |     |       |       |      |      |        |        |        |        |       |       |      |      |     |     |      |      |     |     |      |      |             |             |           |           |             |             |     |     |      |      |         |         |       |       |       |       |              |              |      |      |    |    |          |          |     |     |           |           |         |         |      |      |     |     |       |       |     |     |              |              |                 |                 |
| ・             | スクリーン   |          |   |   |   |   |   |     |     |     |     |     |     |      |      |     |     |    |    |     |     |        |        |     |     |       |       |      |      |        |        |        |        |       |       |      |      |     |     |      |      |     |     |      |      |             |             |           |           |             |             |     |     |      |      |         |         |       |       |       |       |              |              |      |      |    |    |          |          |     |     |           |           |         |         |      |      |     |     |       |       |     |     |              |              |                 |                 |
| ・             | その他   |          |   |   |   |   |   |     |     |     |     |     |     |      |      |     |     |    |    |     |     |        |        |     |     |       |       |      |      |        |        |        |        |       |       |      |      |     |     |      |      |     |     |      |      |             |             |           |           |             |             |     |     |      |      |         |         |       |       |       |       |              |              |      |      |    |    |          |          |     |     |           |           |         |         |      |      |     |     |       |       |     |     |              |              |                 |                 |
| ◎             | スリーブ (つば付鋼管)  |          |   |   |   |   |   |     |     |     |     |     |     |      |      |     |     |    |    |     |     |        |        |     |     |       |       |      |      |        |        |        |        |       |       |      |      |     |     |      |      |     |     |      |      |             |             |           |           |             |             |     |     |      |      |         |         |       |       |       |       |              |              |      |      |    |    |          |          |     |     |           |           |         |         |      |      |     |     |       |       |     |     |              |              |                 |                 |
| ・             | ◎ 印の付いたものを適用する。   |          |   |   |   |   |   |     |     |     |     |     |     |      |      |     |     |    |    |     |     |        |        |     |     |       |       |      |      |        |        |        |        |       |       |      |      |     |     |      |      |     |     |      |      |             |             |           |           |             |             |     |     |      |      |         |         |       |       |       |       |              |              |      |      |    |    |          |          |     |     |           |           |         |         |      |      |     |     |       |       |     |     |              |              |                 |                 |
| 屋外排水設備        | 1 放流納付金 ※ 不要 ・ 要 ( ・ 別途工事 ・ 本工事 )<br>2 配管材料 ※ 硬質塩化ビニル管 (VU)<br>◎ 図示による<br>3 樹類 マンホールは組立式とする。蓋には汚水、雨水等の文字を入れる。<br>蓋の鎖 鉄製蓋 ※ 要 ・ 不要<br>塩化ビニル製蓋 ・ 要 ※ 不要<br>4 樹の深さ ※ 排水を接続する市町の指針、基準等の規定による。<br>・ 以下による。(排水を接続する市町の指針、基準等がない場合)<br>汚水樹 小口径樹 (150mm (流入口径75mm以下に限る)) : 深さ1,000mm以下<br>小口径樹 (200mm) : 深さ1,500mm以下<br>小口径樹 (300mm) : 深さ2,500mm以下<br>雨水樹 (A スカット付) 小口径樹 (150mm) : 深さ1,200mm以下<br>小口径樹 (200mm) : 深さ1,500mm以下<br>小口径樹 (300mm) : 深さ2,500mm以下  | 撤去工事     | 1 冷媒 (フロン系) の回収 ※ 無 ・ 有<br>(1) 冷媒の回収にあたっては、「フロン類の使用の合理化及び管理の適正化に関する法律 (フロン排出抑制法)」に従って行うこと。<br>また、法に規定するものの他、次の書類を監督職員に提出すること。<br>(ア) 第一種フロン類充填回収業者登録通知書の写し<br>(イ) フロン類の処理に関する証明書 (充填証明書、引取証明書等)<br>(2) 行程管理票の様式は、監督職員の指示による。<br>2 家庭用エアコンの処分 家庭用のエアコン等で「特定家庭用機器再商品化法 (家電リサイクル法)」の対象となっているものは、本工事では撤去までとし、処分等については、施設管理者へ引き渡しを行う。<br>3 吸収冷凍機、吸収冷温水機等の美化リチウム水溶液等 ※ 無 ・ 有<br>関係法令に従い、専門業者により適正に処理すること。<br>4 石綿含有建材の除去工事 事前調査 ※ 行う ・ 行わない<br>工事着手に先立ち、目視及び貸与する設計図書等により石綿を含有している建築材料等の使用の有無について調査する。<br>分析による石綿含有建材の調査 ※ 行わない ・ 行う ( 箇所 )<br>測定箇所等は監督職員の指示による。<br>石綿粉じん濃度測定 ※ 行わない ・ 行う ( 箇所 )<br>測定箇所等は監督職員の指示による。<br>石綿作業主任者 石綿作業主任者技能講習修了者又は平成18年3月以前の特定化学物質作業主任者の有   |   |   |   |   |     |     |     |     |     |     |      |      |     |     |    |    |     |     |        |        |     |     |       |       |      |      |        |        |        |        |       |       |      |      |     |     |      |      |     |     |      |      |             |             |           |           |             |             |     |     |      |      |         |         |       |       |       |       |              |              |      |      |    |    |          |          |     |     |           |           |         |         |      |      |     |     |       |       |     |     |              |              |                 |                 |

| 空調機器表(1) |                         |                       |      | 定格能力 |       |      |   | 動力  |                                  |       |       | 消費電力 |      |      |       | 付属品     |    |      |           | 非常電源 | 設置場所 |
|----------|-------------------------|-----------------------|------|------|-------|------|---|-----|----------------------------------|-------|-------|------|------|------|-------|---------|----|------|-----------|------|------|
| 記号       | 名称                      | 型式                    | 冷房能力 | 暖房能力 | 風量    | 機外静圧 | 相 | 電圧  | 出力                               | 冷房    | 暖房    | 加湿器  | フィルタ | リモコン | 冷媒遮断弁 | 冷媒換知警報器 | 台数 | 設置場所 |           |      |      |
|          |                         |                       | KW   | KW   | m3/h  | Pa   |   |     |                                  | φ     | V     |      |      |      |       |         |    | KW   | KW        | 1F   | 2F   |
| EHP-1    | オフィス用マルチエアコン<br>(インバータ) | 室外機                   | 12.5 | 14.0 |       | -    | 3 | 200 | 0.26<br>(FAN)<br>3.59<br>(COMP)  | 3.55  | 4.07  |      |      |      |       |         | 1  |      | 1F 前室(2)  |      |      |
| EHP-1-1  | (室内機)                   | 壁掛形                   | 2.2  | 2.5  | 480   | -    | 1 | 200 | 0.028 (FAN)                      | 0.015 | 0.015 | -    | P    | 1    | 1     | 内蔵      | 1  | -    | B1F 男子更衣室 |      |      |
| EHP-1-2  | (室内機)                   | 4方向天井カセット形<br>(コンパクト) | 2.8  | 3.2  | 540   | -    | 1 | 200 | 0.05 (FAN)                       | 0.043 | 0.036 | -    | P    | 1    | 1     | 内蔵      | 1  | -    | B1F 女子更衣室 |      |      |
| EHP-1-3  | (室内機)                   | 4方向天井カセット形            | 4.5  | 5.0  | 870   | -    | 1 | 200 | 0.053 (FAN)                      | 0.037 | 0.033 | -    | P    | 1    | 1     | 内蔵      | 1  | -    | B1F 職員室   |      |      |
| EHP-1-4  | (室内機)                   | 壁掛形                   | 2.2  | 2.5  | 480   | -    | 1 | 200 | 0.028 (FAN)                      | 0.015 | 0.015 | -    | P    | 1    | 1     | 内蔵      | 1  | -    | B1F 医務室   |      |      |
| EHP-2    | ビル用マルチエアコン<br>(インバータ)   | 室外機<br>ハイグレード         | 33.5 | 37.5 |       | -    | 3 | 200 | 0.54<br>(FAN)<br>8.69<br>(COMP)  | 8.8   | 9.63  |      |      |      |       |         | 1  |      | RF 室外機置場  |      |      |
| EHP-2-1  | (室内機)                   | 4方向天井カセット形            | 5.6  | 6.3  | 930   | -    | 1 | 200 | 0.053 (FAN)                      | 0.043 | 0.038 | -    | P    | 1    | 1     | 内蔵      | 1  | -    | 1F 0歳児保育室 |      |      |
| EHP-2-2  | (室内機)                   | 4方向天井カセット形            | 4.5  | 5.0  | 870   | -    | 1 | 200 | 0.053 (FAN)                      | 0.037 | 0.033 | -    | P    | 2    | 2     | 内蔵      | 2  | -    | 1F 1歳児保育室 |      |      |
| EHP-2-3  | (室内機)                   | 4方向天井カセット形            | 5.6  | 6.3  | 930   | -    | 1 | 200 | 0.053 (FAN)                      | 0.043 | 0.038 | -    | P    | 1    | 1     | 内蔵      | 1  | -    | 1F 2歳児保育室 |      |      |
| EHP-2-4  | (室内機)                   | 4方向天井カセット形            | 3.6  | 4.0  | 750   | -    | 1 | 200 | 0.053 (FAN)                      | 0.028 | 0.024 | -    | P    | 2    | 2     | 内蔵      | 2  | -    | 1F 3歳児保育室 |      |      |
| EHP-3    | ビル用マルチエアコン<br>(インバータ)   | 室外機<br>ハイグレード         | 22.4 | 25.0 |       | -    | 3 | 200 | 0.54<br>(FAN)<br>4.96<br>(COMP)  | 5.29  | 5.73  |      |      |      |       |         | 1  |      | RF 室外機置場  |      |      |
| EHP-3-1  | (室内機)                   | 4方向天井カセット形            | 5.6  | 6.3  | 930   | -    | 1 | 200 | 0.053 (FAN)                      | 0.043 | 0.038 | -    | P    | 2    | -     | -       | 2  | -    | 1F 4歳児保育室 |      |      |
| EHP-3-2  | (室内機)                   | 4方向天井カセット形            | 5.6  | 6.3  | 930   | -    | 1 | 200 | 0.053 (FAN)                      | 0.043 | 0.038 | -    | P    | 2    | -     | -       | 2  | -    | 1F 5歳児保育室 |      |      |
| EHP-4    | ビル用マルチエアコン<br>(インバータ)   | 室外機<br>ハイグレード         | 22.4 | 25.0 |       | -    | 3 | 200 | 0.54<br>(FAN)<br>4.96<br>(COMP)  | 5.29  | 5.73  |      |      |      |       |         | 1  |      | RF 室外機置場  |      |      |
| EHP-4-1  | (室内機)                   | 4方向天井カセット形<br>(コンパクト) | 2.8  | 3.2  | 540   | -    | 1 | 200 | 0.05 (FAN)                       | 0.043 | 0.036 | -    | P    | 1    | 1     | 内蔵      | 1  | -    | 1F 相談室    |      |      |
| EHP-4-2  | (室内機)                   | 4方向天井カセット形            | 7.1  | 8.0  | 1,320 | -    | 1 | 200 | 0.053 (FAN)                      | 0.072 | 0.068 | -    | P    | 1    | 1     | 内蔵      | 1  | -    | 1F 事務室    |      |      |
| EHP-4-3  | (室内機)                   | 2方向天井カセット形            | 4.5  | 5.0  | 720   | -    | 1 | 200 | 0.046 (FAN)                      | 0.041 | 0.037 | -    | P    | 3    | -     | -       | 3  | -    | 1F 廊下(3)  |      |      |
| EHP-5    | ビル用マルチエアコン<br>(インバータ)   | 室外機<br>ハイグレード         | 56.0 | 63.0 |       | -    | 3 | 200 | 1.08<br>(FAN)<br>13.95<br>(COMP) | 14.2  | 15.7  |      |      |      |       |         | 1  |      | RF 室外機置場  |      |      |
| EHP-5-1  | (室内機)                   | 天井埋込ダクト形              | 14.0 | 16.0 | 2,340 | -    | 1 | 200 | 0.35 (FAN)                       | 0.295 | 0.285 | -    | P    | 2    | -     | -       | 2  | -    | 1F 遊戯室(1) |      |      |
| EHP-5-2  | (室内機)                   | 天井埋込ダクト形              | 9.0  | 10.0 | 1,740 | -    | 1 | 200 | 0.35 (FAN)                       | 0.188 | 0.176 | -    | P    | 2    | 2     | 内蔵      | 2  | -    | 1F 遊戯室(2) |      |      |
| EHP-6    | オフィス用マルチエアコン<br>(インバータ) | 室外機                   | 7.1  | 8.0  |       | -    | 3 | 200 | 0.26<br>(FAN)<br>1.53<br>(COMP)  | 1.79  | 1.93  |      |      |      |       |         | 1  |      | 1F 前室(2)  |      |      |
| EHP-6-1  | (室内機)                   | 壁掛形                   | 1.6  | 1.8  | 420   | -    | 1 | 200 | 0.028 (FAN)                      | 0.012 | 0.012 | -    | P    | 1    | 1     | 内蔵      | 1  | -    | 1F 栄養士更衣室 |      |      |
| EHP-6-2  | (室内機)                   | 4方向天井カセット形<br>(コンパクト) | 2.8  | 3.2  | 540   | -    | 1 | 200 | 0.05 (FAN)                       | 0.043 | 0.036 | -    | P    | 1    | 1     | 内蔵      | 1  | -    | 1F 調理員更衣室 |      |      |
| PAC-1    | オフィスエアコン<br>(インバータ)     | 室外機<br>ハイグレード(ツイン同時)  | 25.0 | 28.0 |       | -    | 3 | 200 | 0.454<br>(FAN)<br>5.9<br>(COMP)  | 10.5  | 9.49  |      |      |      |       |         | 1  |      | 1F 前室(2)  |      |      |
| PAC-1-1  | (室内機)                   | 厨房用エアコン               | 14.0 | 16.0 | 1,920 | -    | 1 | 200 | 0.13 (COMP)                      |       |       | -    | P    | 1    | -     | -       | 2  | -    | 1F 調理室    |      |      |

特記事項

- 備考欄に記載なき限り下記とする
- 1) コンクリート基礎は建築工事とする。
  - 2) 室内、室外機間の電気配線(7-8共)は、製造者の標準とし、冷媒管共巻きとする。
  - 3) 使用冷媒: R32
  - 4) 電源は50Hz
  - 5) 機器能力はJIS B8616:2015 条件による。
  - 6) 冷媒漏洩時の安全対策については採用メーカーに合わせて見直すこと。

- 7) 室内機の付属品は下記●印とする
  - 化粧パネル (カセット形のみ ・ 指定色 ●標準色)
  - フィルター ● 防振吊り金物 ( ・ ゴム ● スプリング )
- 8) 室外機の付属品は下記●印とする
  - 防振架台 ( ● スプリング式 ・ ゴムパット式 )
  - アクティブフィルター ● ドレンパン ・ 風向調整板
- 8) EHP-5-1、2は吹出口7'フィルター、吸込分岐ファンを付属とする。
- 9) 室外機は全て重耐塩仕様とする。
- 10) EHP-5-1,2のリモコン色は黒とする。

空調機器表(2)

| 名称     | 型式                        | 機能   | 電源               | 台数 | 設置場所    | 備考 |
|--------|---------------------------|--|------------------|----|---------|----|
| 集中リモコン | 壁掛形液晶コントローラー<br>(タッチパネル式) | 発停、運転モード切替、室温設定 (一括/個別)<br>風量切替、スケジュール制御 (年間、週間、1日複数)<br>64グループ (最大128台) | 1φ=100V<br>19.0W | 1  | B1F 職員室 |    |

送風機機器表

| 記号    | 名称       | 型式                | 風量<br>CMH | 静圧<br>Pa | 動力          |        | 連動   | 24<br>時間<br>換気 | ス<br>イ<br>ッ<br>チ | フ<br>ィ<br>ル<br>タ<br>ー | 台数 | 発停   | 設置場所    |   | 備考   |
|-------|----------|-------------------|-----------|----------|-------------|--------|------|----------------|------------------|-----------------------|----|------|---------|---|--|
|       |          |                   |           |          | 電 源         | 容 量    |      |                |                  |                       |    |      | 階       | 室 名   |  |
| OF-1  | 給気ファン    | ストレートシロッコファン(消音形) | 4,040     | 270      | 3 φ × 200 V | 1.75kW | EF-1 | -              | -                | -                     | 1  | 手元   | 1       | 倉庫(3) ※調理室系統  |  |
| EF-1  | 排気ファン    | 厨房用片吸込みシロッコファン    | 4,470     | 170      | 3 φ × 200 V | 1.5kW  | OF-1 | -              | -                | -                     | 1  | [手元] | R       | 屋上 ※調理室系統   | 重耐塩仕様                                      |
| EF-2  | 排気ファン    | ストレートシロッコファン(消音形) | 250       | 100      | 1 φ × 100 V | 23.6   | -    | -              | -                | -                     | 1  | 手元   | 1       | 沐浴室   |  |
| EF-3  | 排気ファン    | ストレートシロッコファン(消音形) | 350       | 100      | 1 φ × 100 V | 38.1   | -    | -              | -                | -                     | 1  | 手元   | 1       | 乳児用トイレ  |  |
| EF-4  | 排気ファン    | ストレートシロッコファン(消音形) | 650       | 100      | 1 φ × 100 V | 83.2   | -    | -              | -                | -                     | 1  | 手元   | 1       | 幼児用トイレ  |  |
| EF-5  | 排気ファン    | ストレートシロッコファン(消音形) | 700 (40)  | 100      | 1 φ × 100 V | 83.2   | -    | ○              | -                | -                     | 2  | 手元   | 1       | 遊戯室(1)  |  |
| EF-6  | 排気ファン    | ストレートシロッコファン(消音形) | 800 (50)  | 100      | 1 φ × 100 V | 116    | -    | ○              | -                | -                     | 1  | 手元   | 1       | 遊戯室(2)  |  |
| EF-7  | 排気ファン    | ストレートシロッコファン(消音形) | 400       | 100      | 1 φ × 100 V | 62.5   | -    | -              | -                | -                     | 1  | 手元   | 1       | 倉庫(3)   |  |
| HEU-1 | 全熱交換型換気扇 | 天井埋込型             | 150 (20)  | 100      | 1 φ × 100 V | 85     | -    | ○              | ○                | ○                     | 2  | 手元   | 1       | 0歳児保育室、2歳児保育室   |  |
| HEU-2 | 全熱交換型換気扇 | 天井埋込型             | 200 (30)  | 100      | 1 φ × 100 V | 85     | -    | ○              | ○                | ○                     | 3  | 手元   | B1<br>1 | 職員室<br>1歳児保育室、3歳児保育室  |  |
| HEU-3 | 全熱交換型換気扇 | 天井埋込型             | 250 (20)  | 100      | 1 φ × 100 V | 110    | -    | ○              | ○                | ○                     | 1  | 手元   | 1       | 事務室   |  |
| HEU-4 | 全熱交換型換気扇 | 天井埋込型             | 300 (40)  | 100      | 1 φ × 100 V | 210    | -    | ○              | ○                | ○                     | 2  | 手元   | 1       | 4歳児保育室、5歳児保育室   |  |
| VF-1  | 排気ファン    | 天井扇(強弱付・低騒音形)     | 100 (10)  | 50       | 1 φ × 100 V | 2.5    | -    | ○              | -                | -                     | 1  | 手元   | B1      | 医務室   |  |
| VF-2  | 排気ファン    | 天井扇(強弱付・低騒音形)     | 200 (30)  | 50       | 1 φ × 100 V | 19.5   | -    | ○              | -                | -                     | 1  | 手元   | 1       | 調理室   |  |
| VF-3  | 排気ファン    | 天井扇(低騒音形)         | 100       | 50       | 1 φ × 100 V | 14     | -    | -              | -                | -                     | 14 | 手元 ※ | B1<br>1 | 男子更衣室、階段下倉庫、給湯室、トイレ(1)<br>栄養士更衣室、検収室、食品庫、調理員トイレ、調理員更衣室、調乳室、下足コーナー(2)、トイレ(2)、みんなのトイレ、相談室 | ※トイレ(1)、(2)、みんなのトイレ、<br>調理員トイレは人感センサー連動とする |
| VF-4  | 排気ファン    | 天井扇(低騒音形)         | 150       | 50       | 1 φ × 100 V | 20     | -    | -              | -                | -                     | 5  | 手元   | B1<br>1 | 女子更衣室、下足コーナー(1)、倉庫(1)   |  |
| VF-5  | 排気ファン    | 天井扇(低騒音形)         | 200       | 50       | 1 φ × 100 V | 26.0   | -    | -              | -                | -                     | 1  | 手元   | B1      | 洗濯室、倉庫(5)   |  |
| VF-6  | 排気ファン    | 天井扇(低騒音形)         | 300       | 50       | 1 φ × 100 V | 49.0   | -    | -              | -                | -                     | 1  | 手元   | 1       | 廊下(3)   |  |

- 特記事項
- 1) 電源50Hz
  - 2) ( )内は24時間換気運転時の能力とする。
  - 3) 24時換気の項目に『○』と明記してあるものは建築基準法のシックハウス対策として24時間換気を行う。
  - 4) 全熱交換器以外の24時間運転箇所については24時間換気リモコンスイッチ(強弱付)を付属品とする。(取り付け、配線は電気工事)
  - 5) コンクリート基礎は建築工事とする。
  - 6) EF-1、OF-1はインバーター制御とする(インバーターは電気工事)
  - 7) EF-1はスプリング式防振架台を付属とする。
  - 8) OF-1、EF-2~6は防振吊り金物付属とする。

凡例

| 記号              | 名称        | 仕様  |
|-----------------|-----------|---|
| —SA—            | 給気風道      | 亜鉛鉄板 スパイラルダクト                                 |
| —RA—            | 遠気風道      | 亜鉛鉄板 スパイラルダクト                                 |
| —OA—            | 外気風道      | 亜鉛鉄板 スパイラルダクト                                 |
| —EA—            | 排気風道(一般)  | 亜鉛鉄板 スパイラルダクト                                 |
| —EA—            | 排気ダクト(厨房) | 亜鉛鉄板(アングル工法) スパイラルダクト<br>屋外ステンレスダクト           |
| ○ <sub>VD</sub> | 風量調整ダンパー  |   |
| ○ <sub>OD</sub> | 逆流防止ダンパー  |   |
| ● <sub>FD</sub> | 防火ダンパー    |   |
| ● <sub>SD</sub> | 排煙ダンパー    |   |
| ☒               | 吹出口       | 指定色焼付け塗装仕上げ                                   |
| ☒               | 吸込口       | 指定色焼付け塗装仕上げ                                   |
| ☒               | 天井扇       |   |
| ☒               | ライファン     | 消音型   |
| → ◁ ○           | バンドキャップ   | ステンレス製(指定色焼付け塗装、フラット型)                        |
| —R—             | 冷媒管       | 冷媒用被覆銅管                                       |
| —D—             | ドレン管      | 屋内：耐火二層管<br>ビット内、屋外、埋設：硬質塩化ビニル管(VP)<br>(建築工事) |
| → DG            | ドアガラリ     | (建築工事)  |
| → UC            | アンダーカット   | (建築工事)  |

フィルターボックス機器表

| 記号   | 名称      | 型式                      | 機能  | 台数 | 設置場所          | 備考 |
|------|---------|-------------------------|---|----|---------------|----|
| FU-1 | 給気フィルター | 阻じんフィルター<br>(パネル型、BOX付) | 仕様 質量法 82%以上<br>外形寸法 : 900W × 600D × 600H<br>フィルター寸法 : 450W × 600H × 2枚<br>処理風量 : 4,040m3/h | 1  | 1F 倉庫3(調理室系統) |    |

備考欄に記載なき限り下記とする。

- 1) フィルターは予備品(1組)用意する。
- 2) フィルターの面風速は2.5m/s以下とする。

特記事項

1. 空調屋内外機の渡り配線(CVVS2口-2C)は冷媒管共巻きし本工事とする。
2. 配管が令112条20項、21項に規定する防火区画および、令114条に規定する界壁、防火上主要な間仕切壁または隔壁を貫通する場合は防火区画貫通処理を行うものとし、下記によること。
  - 冷媒管 国土交通大臣認定工法による。
  - ※国土交通大臣認定番号(下記または同等とする)  
(壁用)PS060WL-0131、PS060WL-0130、PS060WL-0196  
(床用)PS060FL-0129、PS060WL-0185
  - ドレン管 国土交通大臣認定工法による。
  - ※国土交通大臣認定番号(下記または同等とする)  
(壁用)PS060WL-1071、PS060WL-0172  
(床用)PS060FL-1070
3. 建築設備の構造は、平12建告第1388号に適合すること。
4. 屋上に設置される建築設備は、平12建告第1389号に規定する構造計算に基づき設置すること。
5. 防火ダンパーの構造及び設置方法は、昭48建告第2565号及び平12建告1376号に適合すること。
6. 火を使用する建築設備は、火災予防条例の規定に基づき設置するものとし、下記によること。
  - //// の範囲はロックウール50mm又は防火断熱材20mm(国土交通大臣認定品)巻きとする。
7. ダクトの保温は下記による。
  - 外気取入れダクト、給気ダクト : GW25mm巻き (ガラリチャンバー、制気口BOX共)
  - 排気ダクト : 外壁から1mまでGW25mm巻き
  - ※全熱交換器の一次側ダクト(外気取入れ、排気)は全て保温とし、二次側ダクト(給気、還気)は保温不要とする。
8. 24時間換気機器のスイッチには、24時間運転用の表記を行う。
9. FD設置部には天井点検口(450x450)を設置する。(建築工事)

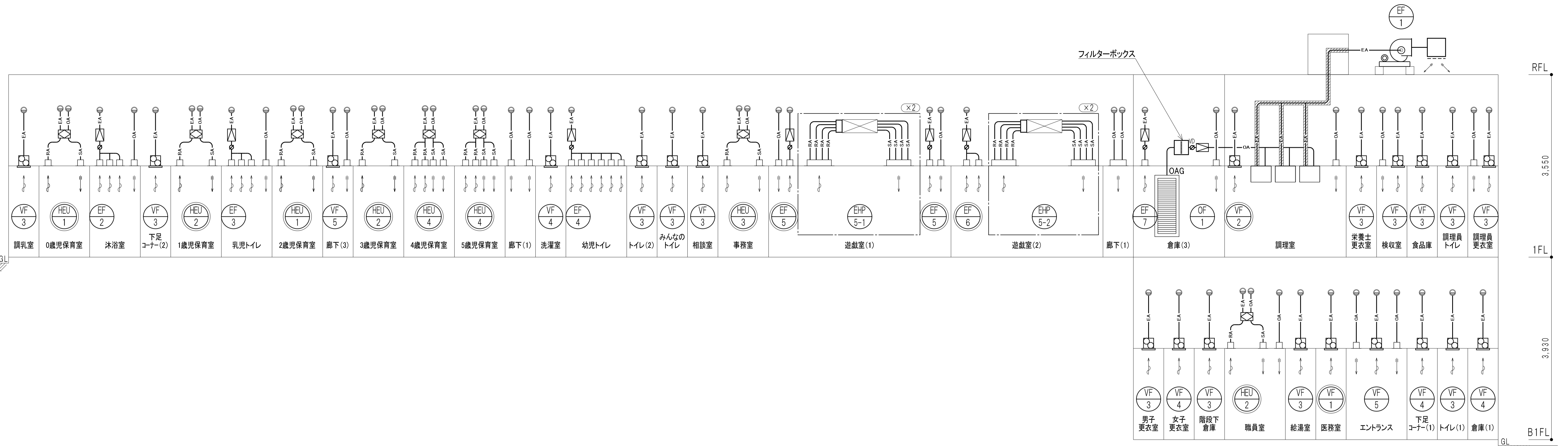

ダクト系統図

| 記号  | 冷媒サイズ         |
|-----|---------------|
| (A) | 6.4φ × 12.7φ  |
| (B) | 9.5φ × 15.9φ  |
| (C) | 9.5φ × 19.1φ  |
| (D) | 9.5φ × 22.2φ  |
| (E) | 9.5φ × 25.4φ  |
| (F) | 12.7φ × 25.4φ |

凡例

- 冷媒管区画貫通処理
- 冷媒用遮断弁

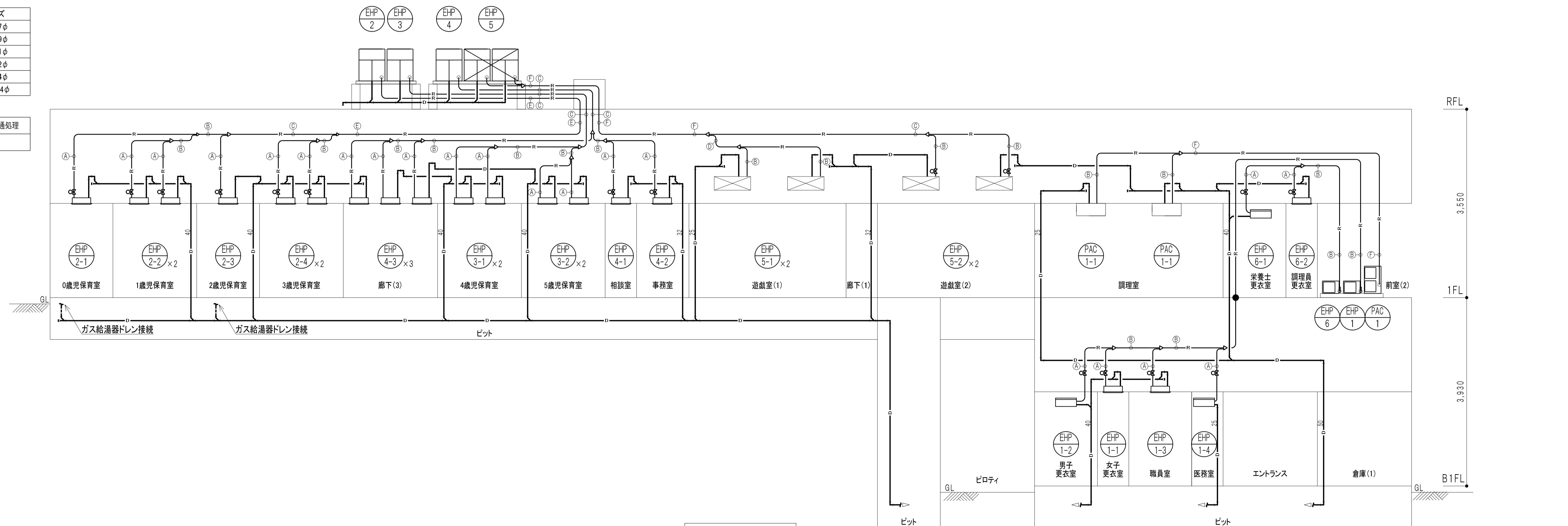

配管系統図

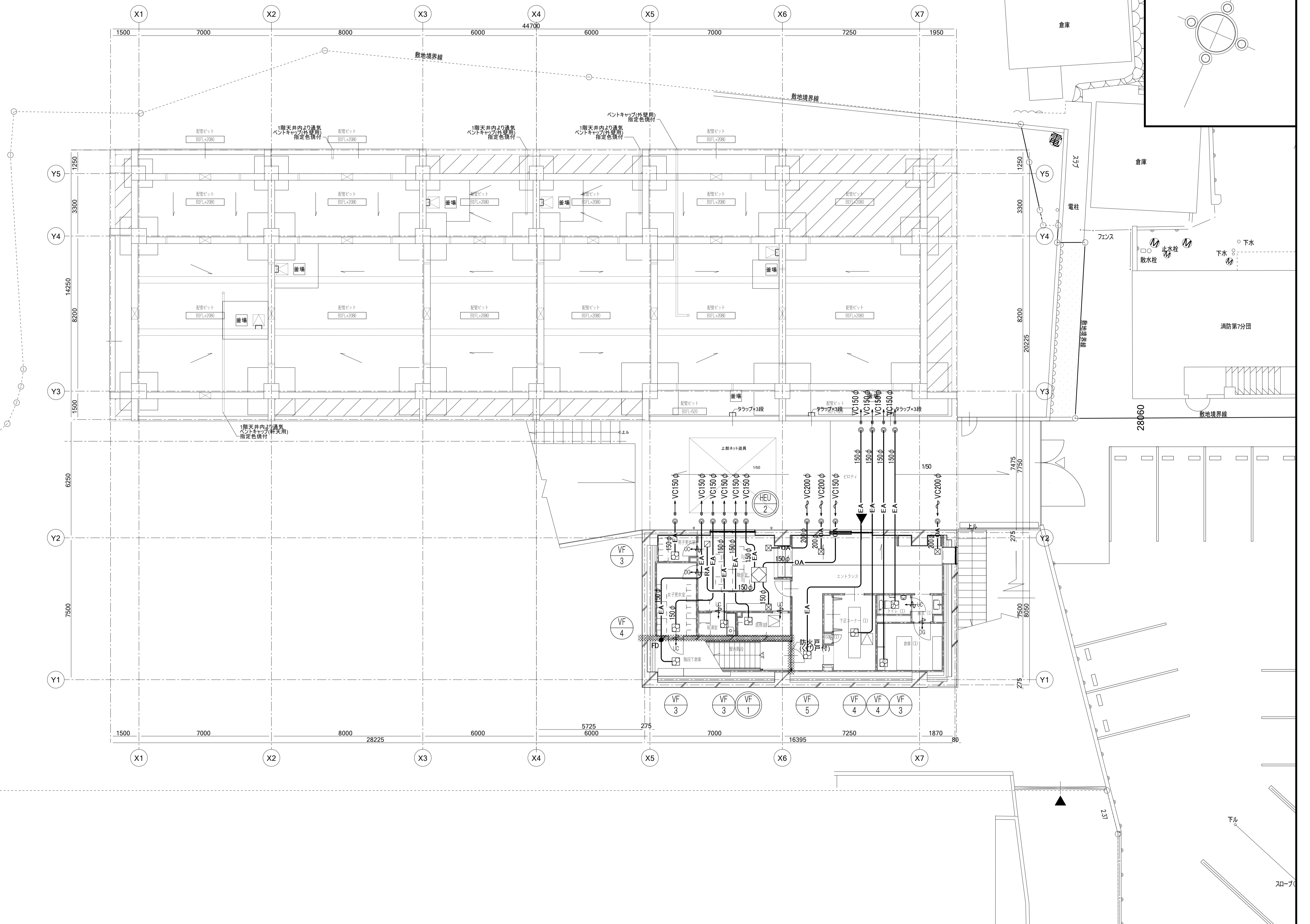

| 制気口リスト |                          |
|--------|--------------------------|
| 室名     | 職員室                      |
| 器具名    | VHS 200×200              |
| 風量     | SA 200 m <sup>3</sup> /h |
| ボックス   | 300×300×300H (内貼り25mm)   |
|        | ×1                       |
| 室名     | 職員室                      |
| 器具名    | HS 200×200               |
| 風量     | RA 200 m <sup>3</sup> /h |
| ボックス   | 300×300×300H (内貼り25mm)   |
|        | ×1                       |
| 室名     | 職員室                      |
| 器具名    | VHS 300×300              |
| 風量     | OA 400 m <sup>3</sup> /h |
| ボックス   | 400×400×300H (内貼り25mm)   |
|        | ×1                       |
|        | フィルター付                   |
| 室名     | エントランス                   |
| 器具名    | VHS 250×250              |
| 風量     | OA 300 m <sup>3</sup> /h |
| ボックス   | 350×350×300H (内貼り25mm)   |
|        | ×2                       |
|        | フィルター付                   |

〰〰〰 令114条による防火上主要な間仕切壁・隔壁  
 〰〰〰〰 令112条11項 間仕切壁

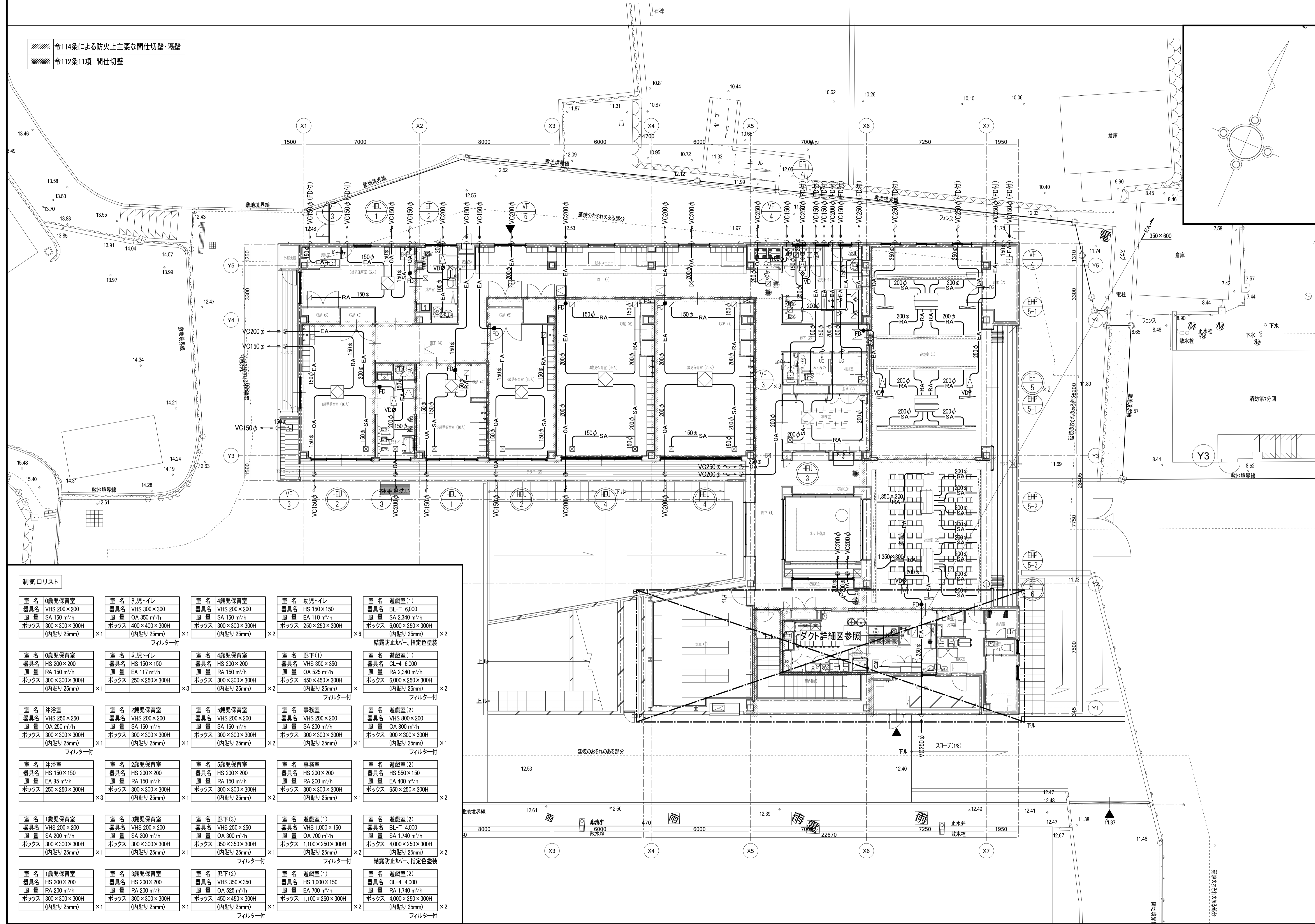

| 制気口リスト   |  |  |  |   |
|--|--|--|--|---|
| 室名 0歳児保育室<br>器具名 VHS 200×200<br>風量 SA 150 m <sup>3</sup> /h<br>ボックス 300×300×300H<br>(内貼り 25mm)<br>×1 | 室名 乳児トイレ<br>器具名 VHS 300×300<br>風量 OA 350 m <sup>3</sup> /h<br>ボックス 400×400×300H<br>(内貼り 25mm)<br>×1  | 室名 4歳児保育室<br>器具名 VHS 200×200<br>風量 SA 150 m <sup>3</sup> /h<br>ボックス 300×300×300H<br>(内貼り 25mm)<br>×2 | 室名 幼児トイレ<br>器具名 HS 150×150<br>風量 EA 110 m <sup>3</sup> /h<br>ボックス 250×250×300H<br>(内貼り 25mm)<br>×6       | 室名 遊戯室(1)<br>器具名 BL-T 6,000<br>風量 SA 2,340 m <sup>3</sup> /h<br>ボックス 6,000×250×300H<br>(内貼り 25mm)<br>×2 |
| フィルター付   |  |  |  |   |
| 室名 0歳児保育室<br>器具名 HS 200×200<br>風量 RA 150 m <sup>3</sup> /h<br>ボックス 300×300×300H<br>(内貼り 25mm)<br>×1  | 室名 乳児トイレ<br>器具名 HS 150×150<br>風量 EA 117 m <sup>3</sup> /h<br>ボックス 250×250×300H<br>(内貼り 25mm)<br>×3   | 室名 4歳児保育室<br>器具名 HS 200×200<br>風量 RA 150 m <sup>3</sup> /h<br>ボックス 300×300×300H<br>(内貼り 25mm)<br>×2  | 室名 廊下(1)<br>器具名 VHS 350×350<br>風量 OA 525 m <sup>3</sup> /h<br>ボックス 450×450×300H<br>(内貼り 25mm)<br>×1      | 室名 遊戯室(1)<br>器具名 CL-4 6,000<br>風量 RA 2,340 m <sup>3</sup> /h<br>ボックス 6,000×250×300H<br>(内貼り 25mm)<br>×2 |
| フィルター付   |  |  |  |   |
| 室名 浴室<br>器具名 VHS 250×250<br>風量 OA 250 m <sup>3</sup> /h<br>ボックス 300×300×300H<br>(内貼り 25mm)<br>×1     | 室名 2歳児保育室<br>器具名 VHS 200×200<br>風量 SA 150 m <sup>3</sup> /h<br>ボックス 300×300×300H<br>(内貼り 25mm)<br>×1 | 室名 5歳児保育室<br>器具名 VHS 200×200<br>風量 SA 150 m <sup>3</sup> /h<br>ボックス 300×300×300H<br>(内貼り 25mm)<br>×2 | 室名 事務室<br>器具名 VHS 200×200<br>風量 SA 200 m <sup>3</sup> /h<br>ボックス 300×300×300H<br>(内貼り 25mm)<br>×1        | 室名 遊戯室(2)<br>器具名 VHS 800×200<br>風量 OA 800 m <sup>3</sup> /h<br>ボックス 900×300×300H<br>(内貼り 25mm)<br>×1    |
| フィルター付   |  |  |  |   |
| 室名 浴室<br>器具名 HS 150×150<br>風量 EA 85 m <sup>3</sup> /h<br>ボックス 250×250×300H<br>(内貼り 25mm)<br>×3       | 室名 2歳児保育室<br>器具名 HS 200×200<br>風量 RA 150 m <sup>3</sup> /h<br>ボックス 300×300×300H<br>(内貼り 25mm)<br>×1  | 室名 5歳児保育室<br>器具名 HS 200×200<br>風量 RA 150 m <sup>3</sup> /h<br>ボックス 300×300×300H<br>(内貼り 25mm)<br>×2  | 室名 事務室<br>器具名 HS 200×200<br>風量 RA 200 m <sup>3</sup> /h<br>ボックス 300×300×300H<br>(内貼り 25mm)<br>×1         | 室名 遊戯室(2)<br>器具名 HS 550×150<br>風量 EA 400 m <sup>3</sup> /h<br>ボックス 650×250×300H<br>(内貼り 25mm)<br>×2     |
| フィルター付   |  |  |  |   |
| 室名 1歳児保育室<br>器具名 VHS 200×200<br>風量 SA 200 m <sup>3</sup> /h<br>ボックス 300×300×300H<br>(内貼り 25mm)<br>×1 | 室名 3歳児保育室<br>器具名 VHS 200×200<br>風量 SA 200 m <sup>3</sup> /h<br>ボックス 300×300×300H<br>(内貼り 25mm)<br>×1 | 室名 廊下(3)<br>器具名 VHS 250×250<br>風量 OA 300 m <sup>3</sup> /h<br>ボックス 350×350×300H<br>(内貼り 25mm)<br>×1  | 室名 遊戯室(1)<br>器具名 VHS 1,000×150<br>風量 OA 700 m <sup>3</sup> /h<br>ボックス 1,100×250×300H<br>(内貼り 25mm)<br>×2 | 室名 遊戯室(2)<br>器具名 BL-T 4,000<br>風量 SA 1,740 m <sup>3</sup> /h<br>ボックス 4,000×250×300H<br>(内貼り 25mm)<br>×2 |
| フィルター付   |  |  |  |   |
| 室名 1歳児保育室<br>器具名 HS 200×200<br>風量 RA 200 m <sup>3</sup> /h<br>ボックス 300×300×300H<br>(内貼り 25mm)<br>×1  | 室名 3歳児保育室<br>器具名 HS 200×200<br>風量 RA 200 m <sup>3</sup> /h<br>ボックス 300×300×300H<br>(内貼り 25mm)<br>×1  | 室名 廊下(2)<br>器具名 VHS 350×350<br>風量 OA 525 m <sup>3</sup> /h<br>ボックス 450×450×300H<br>(内貼り 25mm)<br>×1  | 室名 遊戯室(1)<br>器具名 HS 1,000×150<br>風量 EA 700 m <sup>3</sup> /h<br>ボックス 1,100×250×300H<br>(内貼り 25mm)<br>×2  | 室名 遊戯室(2)<br>器具名 CL-4 4,000<br>風量 RA 1,740 m <sup>3</sup> /h<br>ボックス 4,000×250×300H<br>(内貼り 25mm)<br>×2 |
| フィルター付   |  |  |  |   |

ダクト詳細図参照

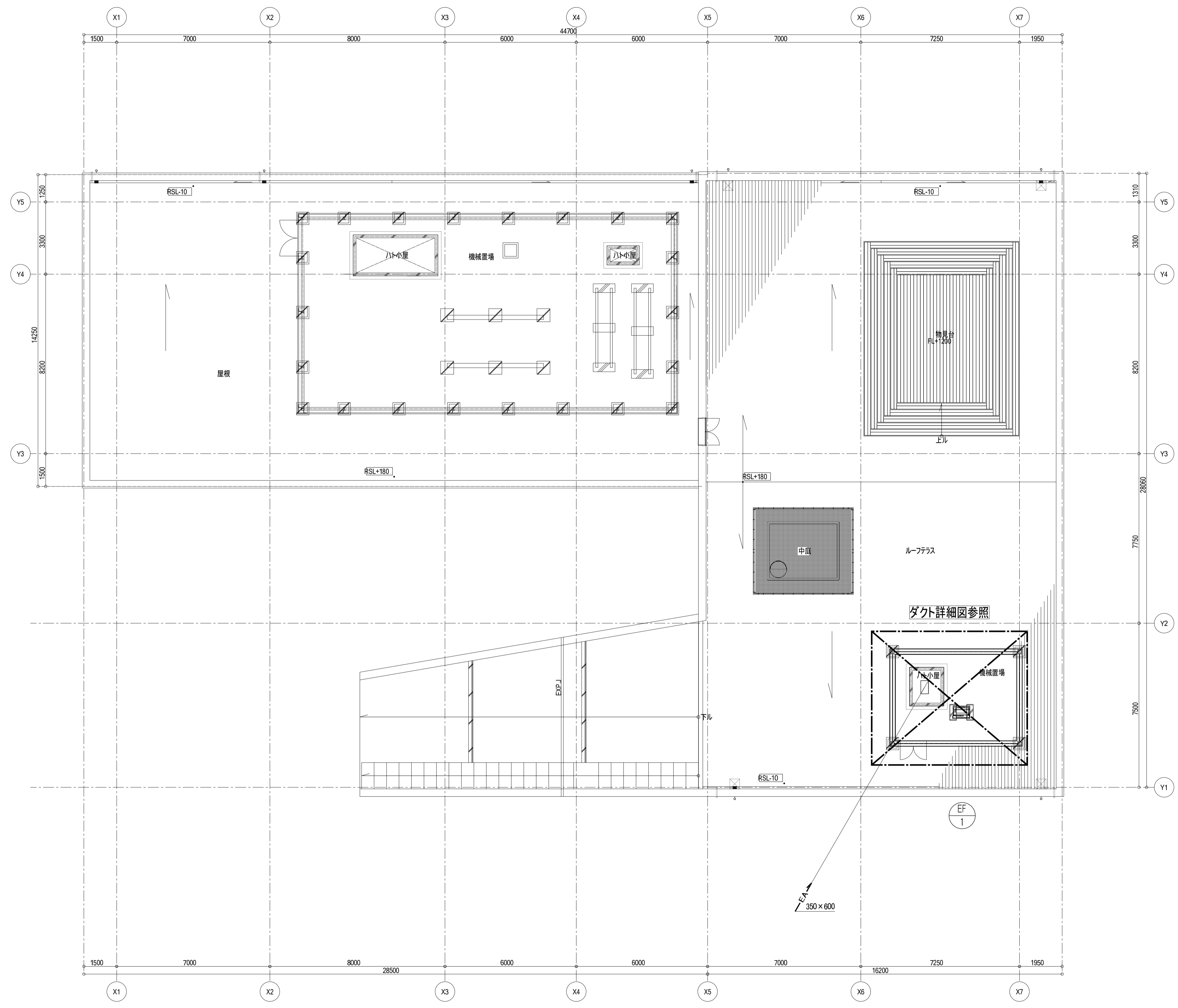
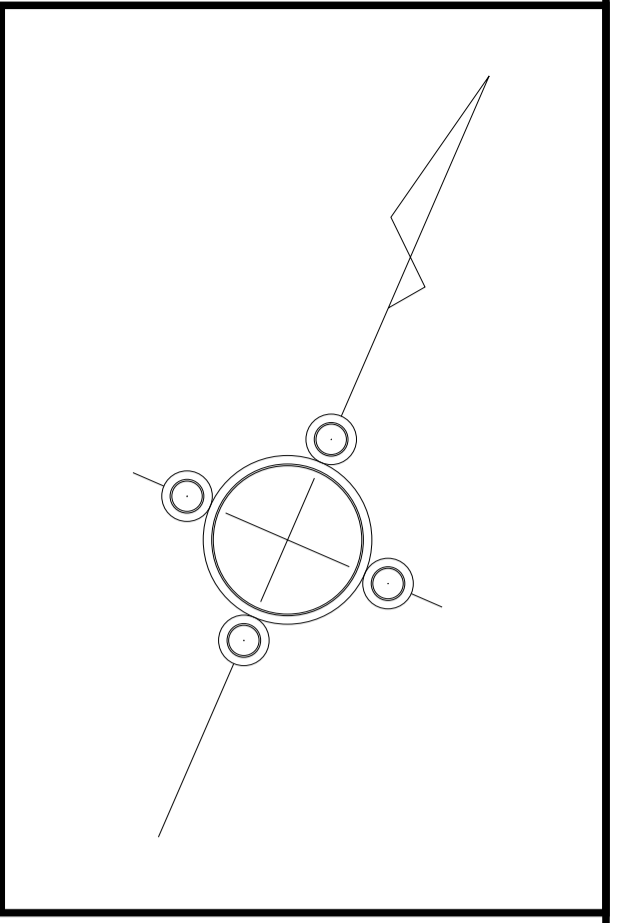

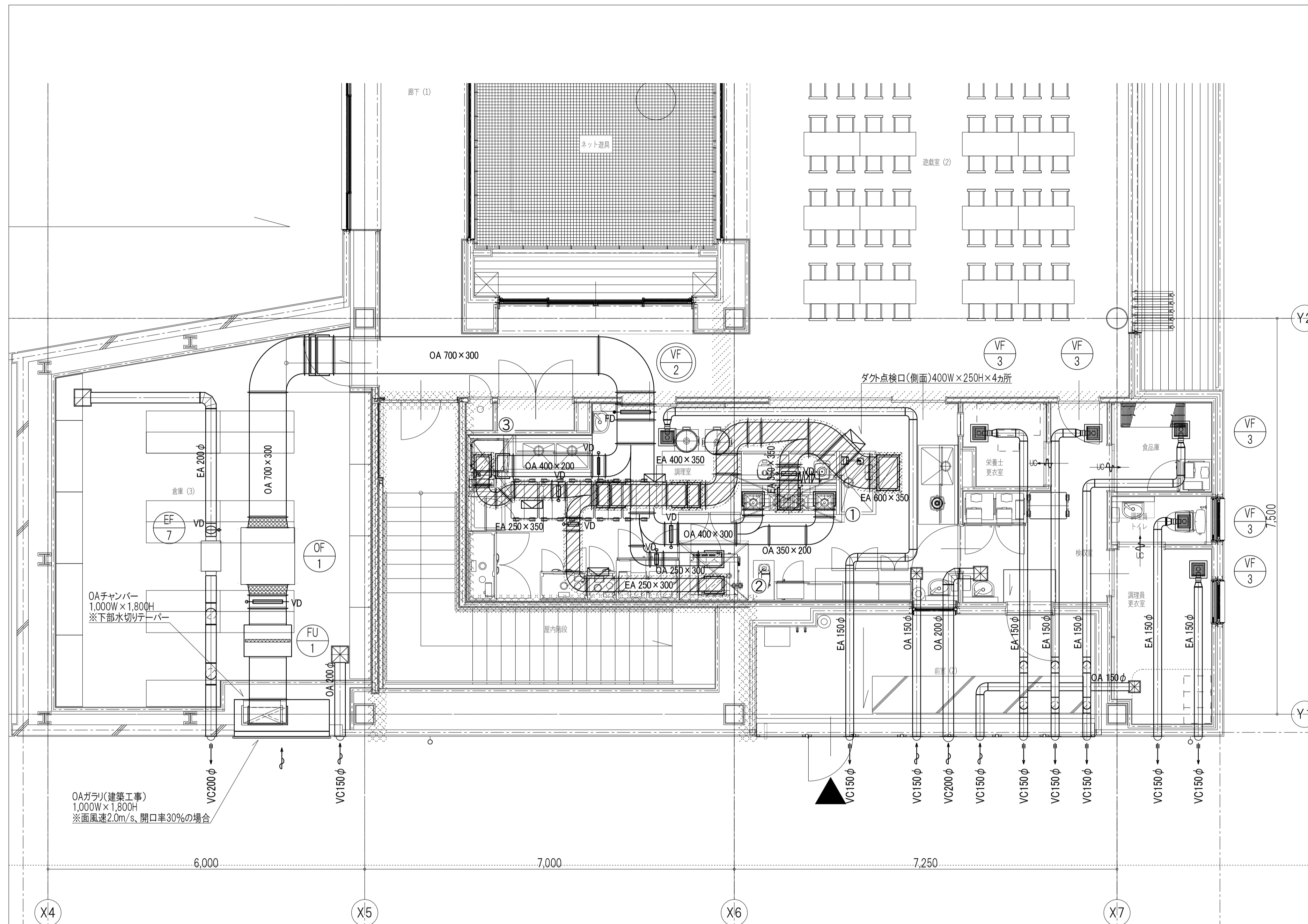

1階ダクト詳細図

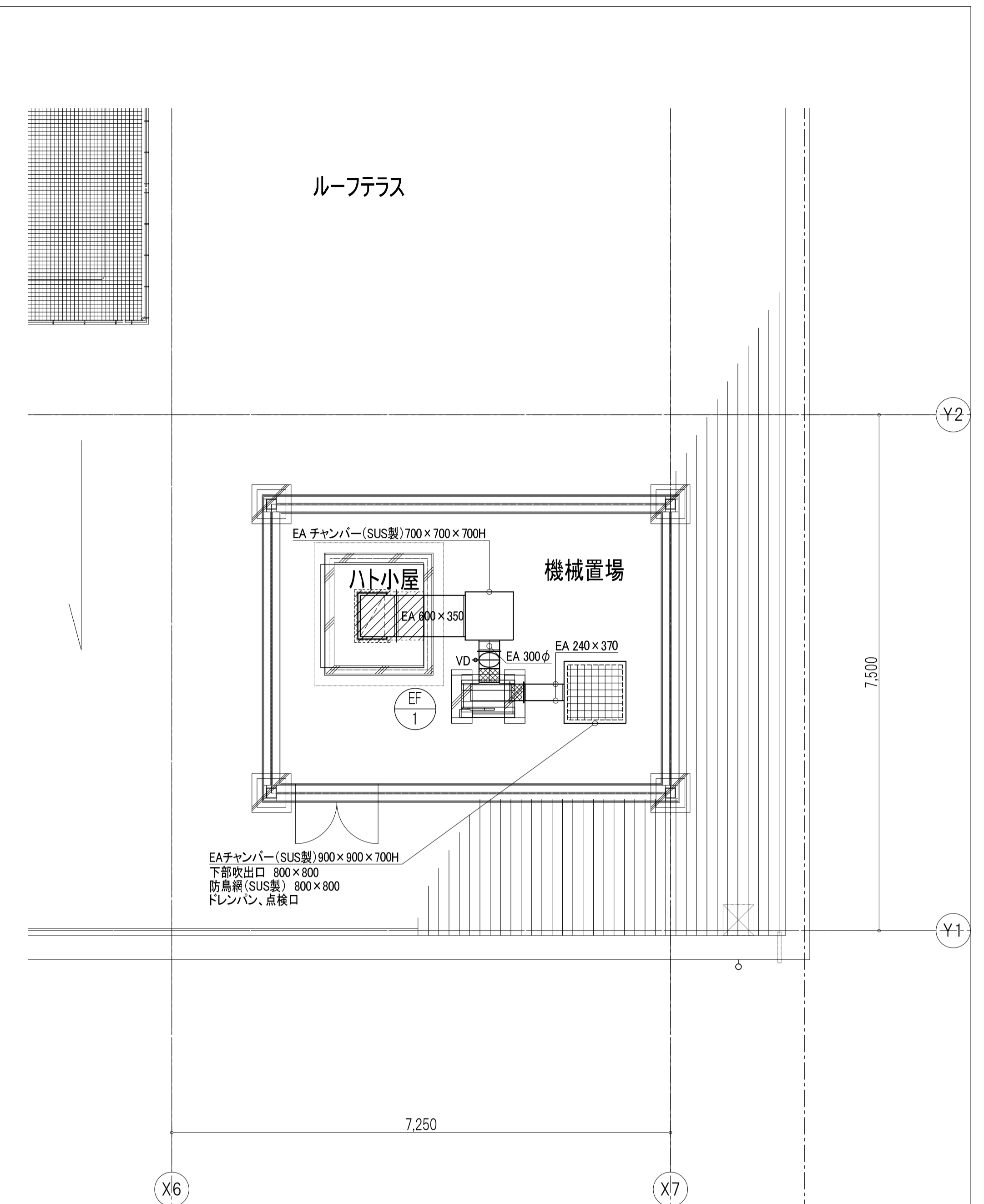

屋上ダクト詳細図

フードリスト

| 室名  | フード記号 | 厨房機器番号 | 器具名         | ①火気使用による必要換気量                       |                  |             |                            |                                   | ②排気フード面風速による必要換気量 |             |                      |                   |                            | FD   | GF    | 排気ファン                      |                         | 給気ファン |                         |       |                  |
|-----|-------|--------|-------------|-------------------------------------|------------------|-------------|----------------------------|-----------------------------------|-------------------|-------------|----------------------|-------------------|----------------------------|------|-------|----------------------------|-------------------------|-------|-------------------------|-------|------------------|
|     |       |        |             | ガス器具                                |                  |             | 電気式器具                      |                                   | 計                 | フード寸法<br>mm | 面積<br>m <sup>2</sup> | 面風速<br>m/h        | 必要換気量<br>m <sup>3</sup> /h |      |       | 決定換気量<br>m <sup>3</sup> /h | 風量<br>m <sup>3</sup> /h | 記号    | 風量<br>m <sup>3</sup> /h | 記号    |                  |
|     |       |        |             | 理論排ガス量<br>K<br>m <sup>3</sup> /KW·h | 燃料消費量<br>Q<br>KW | 排気装置別<br>定数 | 必要換気量<br>m <sup>3</sup> /h | 換気系数<br>E<br>m <sup>3</sup> /KW·h |                   |             |                      |                   |                            |      |       |                            |                         |       |                         |       | 電気式器具<br>P<br>KW |
| 調理室 | ①     | C-3    | ガステーブル      | 0.93                                | 49.60            | 30          | 1,384                      |                                   |                   |             |                      | 2,100 × 900 × 700 | 1.89                       | 0.30 | 2,041 | 2,050                      | ○                       | ○     | 2,050                   | 1,850 |                  |
|     |       |        | ②           | C-11 スチームコンベクションオープン                |                  |             |                            |                                   | 30                | 10.10       | 303                  | 303               | 1,050 × 1,100 × 700        | 1.16 | 0.30  | 1,247                      | 1,250                   | ○     | ○                       | 1,250 | 1,130            |
|     |       |        | ③           | E-3 食器洗浄機                           |                  |             |                            |                                   | 30                | 5.06        | 152                  | 821               | 900 × 1,200 × 700          | 1.08 | 0.30  | 1,166                      | 1,170                   | ○     | -                       | 1,170 | 1,060            |
|     |       |        | E-4 ガスブースター | 0.93                                | 24.00            | 30          | 670                        |                                   |                   |             |                      |                   |                            |      |       |                            |                         |       |                         |       |                  |
|     |       |        | [合計]        |                                     | 73.60            |             |                            |                                   | 15.16             | 2,508       |                      |                   |                            |      |       |                            |                         | 4,470 | 4,470                   | 4,040 |                  |

- 特記事項
- フード下面は火源より1.0m以内とする。(告示(イ)I型フード該当品)
  - グリスフィルター下面は火源より1.0m以上離すこと。
  - 排気フードに設けるFDのヒューズ温度は120°Cとする。
  - 排気フードはSUS(304)製二重型吹出口(VHS、下部・側面吹出)付(化粧幕板付)へアーライン仕上げとする。(グリスカップ付属)
  - グリスフィルターは低圧損タイプを使用すること。
  - フード内のLED照明はオプション対応とする。

制気口リスト

|           |                   |                             |                                  |    |          |                   |                             |                                  |    |
|-----------|-------------------|-----------------------------|----------------------------------|----|----------|-------------------|-----------------------------|----------------------------------|----|
| 室名 調理室    | 器具名 VHS 200 × 200 | 風量 OA 200 m <sup>3</sup> /h | ボックス 300 × 300 × 300H (内貼り 25mm) | ×1 | 室名 倉庫(3) | 器具名 VHS 300 × 300 | 風量 OA 400 m <sup>3</sup> /h | ボックス 400 × 400 × 300H (内貼り 25mm) | ×1 |
|           | フィルタ付             |                             |                                  |    |          | フィルタ付             |                             |                                  |    |
| 室名 検収室    | 器具名 VHS 250 × 250 | 風量 OA 300 m <sup>3</sup> /h | ボックス 300 × 300 × 300H (内貼り 25mm) | ×1 | 室名 倉庫(3) | 器具名 HS 300 × 300  | 風量 EA 400 m <sup>3</sup> /h | ボックス 400 × 400 × 300H            | ×1 |
|           | フィルタ付             |                             |                                  |    |          | フィルタ付             |                             |                                  |    |
| 室名 調理士更衣室 | 器具名 VHS 200 × 200 | 風量 OA 200 m <sup>3</sup> /h | ボックス 300 × 300 × 300H (内貼り 25mm) | ×1 |          |                   |                             |                                  |    |
|           | フィルタ付             |                             |                                  |    |          |                   |                             |                                  |    |

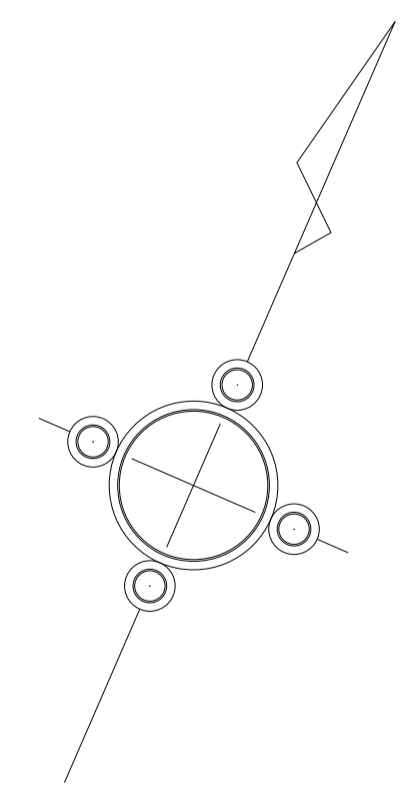

| 記号 | 冷媒サイズ         |
|----|---------------|
| A  | 6.4φ × 12.7φ  |
| B  | 9.5φ × 15.9φ  |
| C  | 9.5φ × 19.1φ  |
| D  | 9.5φ × 22.2φ  |
| E  | 9.5φ × 25.4φ  |
| F  | 12.7φ × 25.4φ |

|  |                       |
|--|-----------------------|
|  | 令114条による防火上主要な間仕切壁・隔壁 |
|  | 令112条11項 間仕切壁         |
|  | 冷媒用遮断弁                |

※国土交通認定工法による  
 区画貫通処理が必要な箇所は、  
 ●— 左記の凡例部とする。

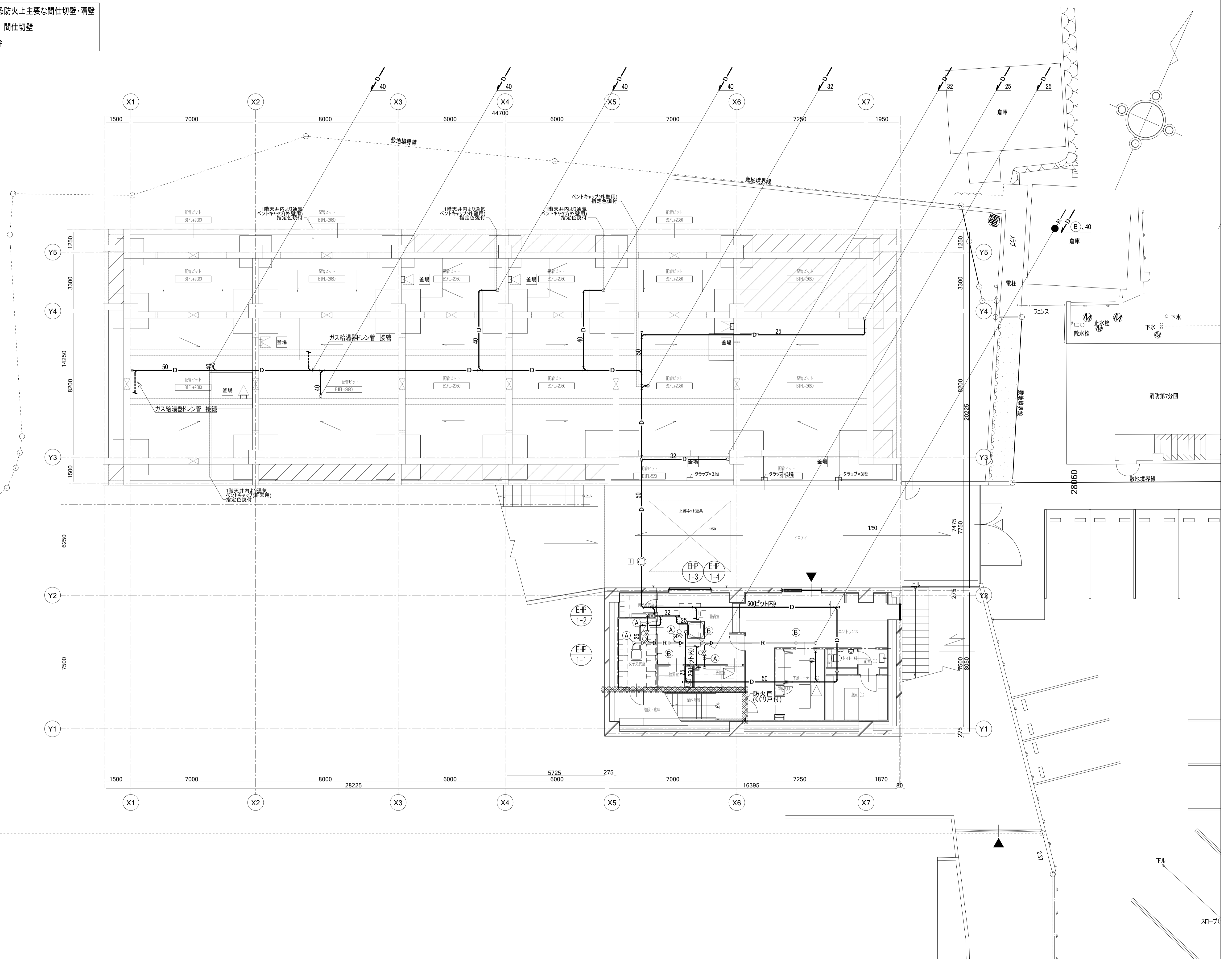



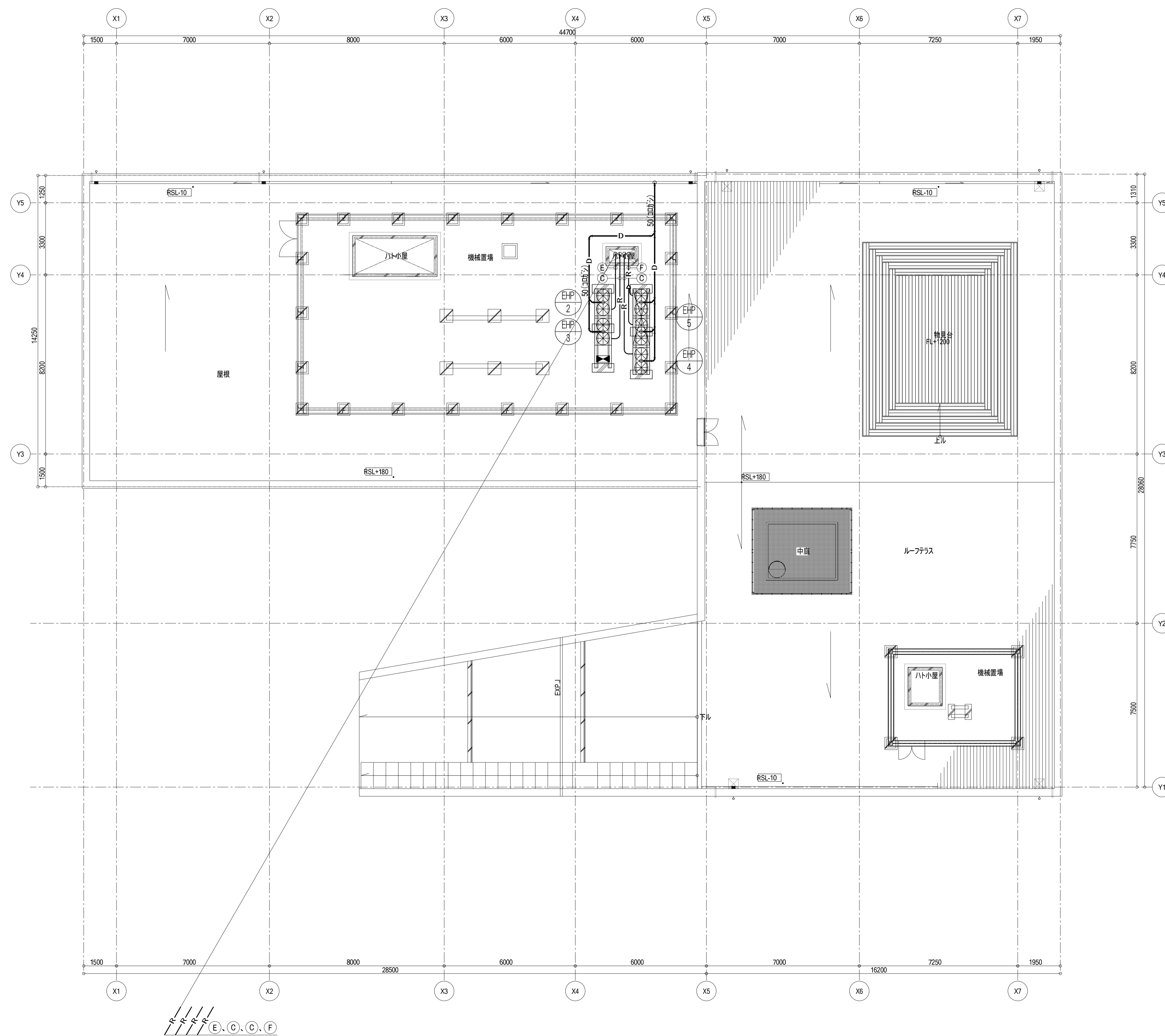
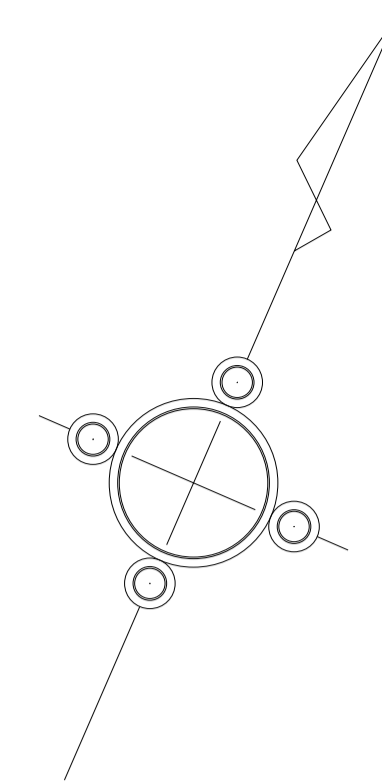

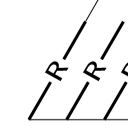
 株式会社 日比野設計  
 一級建築士事務所 神奈川県知事登録 第20117号  
 一級建築士 東274650号 伊東 陽子

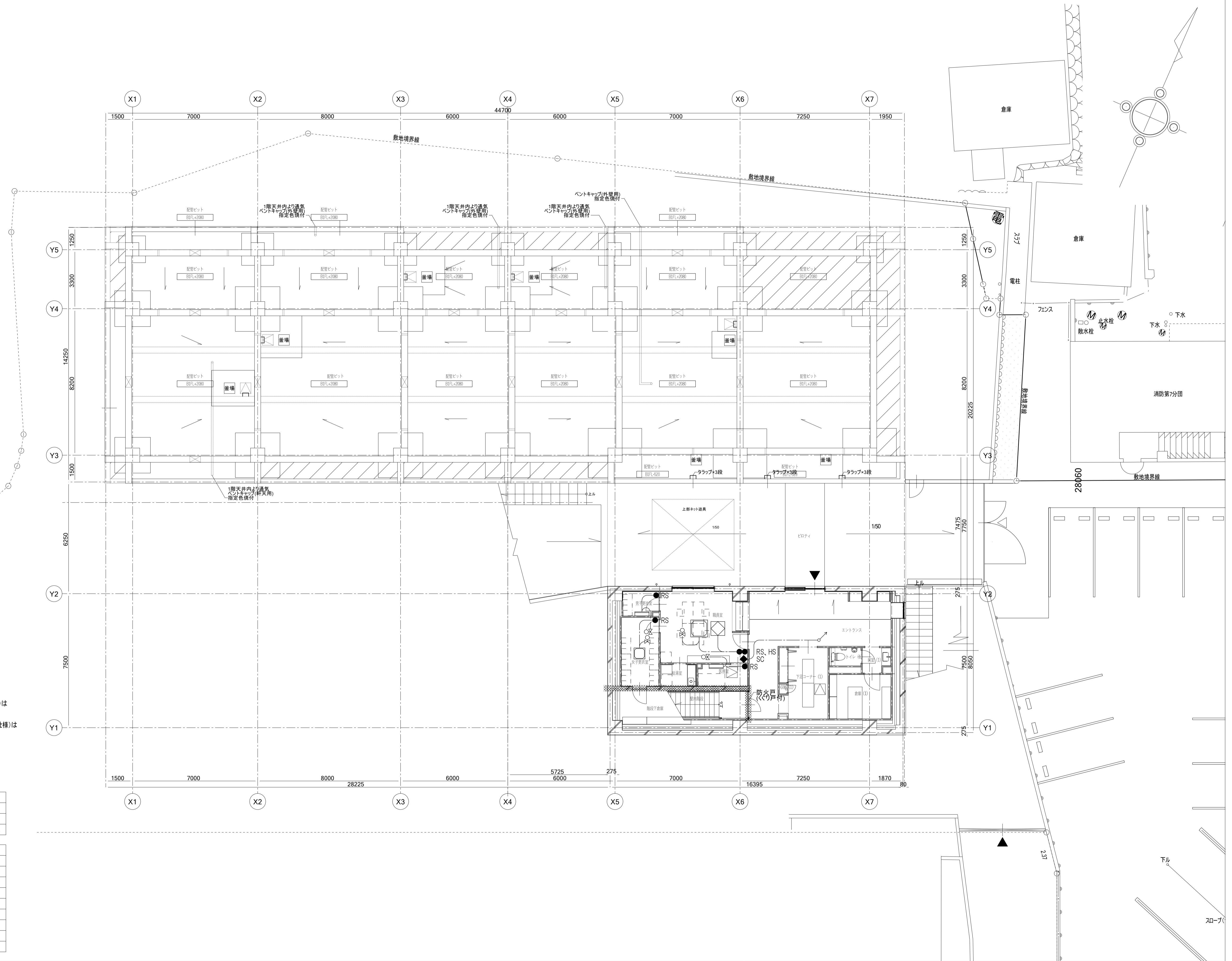

令114条による防火上主要な間仕切壁・隔壁  
 令112条11項 間仕切壁

- 特記事項**
- 国土交通大臣認定工法による区画貫通処理が必要な箇所は、●を左記を凡例部とする。
  - 屋内外機渡り配線配管及びスイッチ用配線配管 (EM-CEES2.0°-2C) は冷媒管共巻きとし本工事とする。
  - 室内機のリモコン用制御配線 (EM-CEES2.0°-2C) はメーカー推奨仕様は本工事とする。
  - 給湯器の制御配線は機器付属品とする。
  - 建築設備の設置については令129条の2の4及び平12建告1388号、1389号に定める構造とする。
  - 電源供給工事は電気工事とする。

特記なき配線は下記による。

|     |                      |           |
|-----|----------------------|-----------|
| --- | EM-CEES2.0°-2C(G22)  | 屋外露出配管配線  |
| --- | EM-CEES2.0°-2C(PF22) | 屋内露出配管配線  |
| --- | EM-CEES2.0°-2C(PF22) | 天井こもり配管配線 |

特記なき記号は下記による。

| 記号  | 名称                          |
|-----|-----------------------------|
| ●RS | 空調機用リモコンスイッチ                |
| ●HS | 全熱交換器用リモコンスイッチ              |
| ●GS | ガス給湯器用リモコンスイッチ              |
| ◆SC | 集中リモコン(SC-1)                |
| □   | プルボックス(150x150x150)         |
| □WP | プルボックス(防水形、SUS、150x150x150) |
| □LG | ガス漏れ警報器(LGガス用)              |
| □   | 冷媒遮断弁                       |



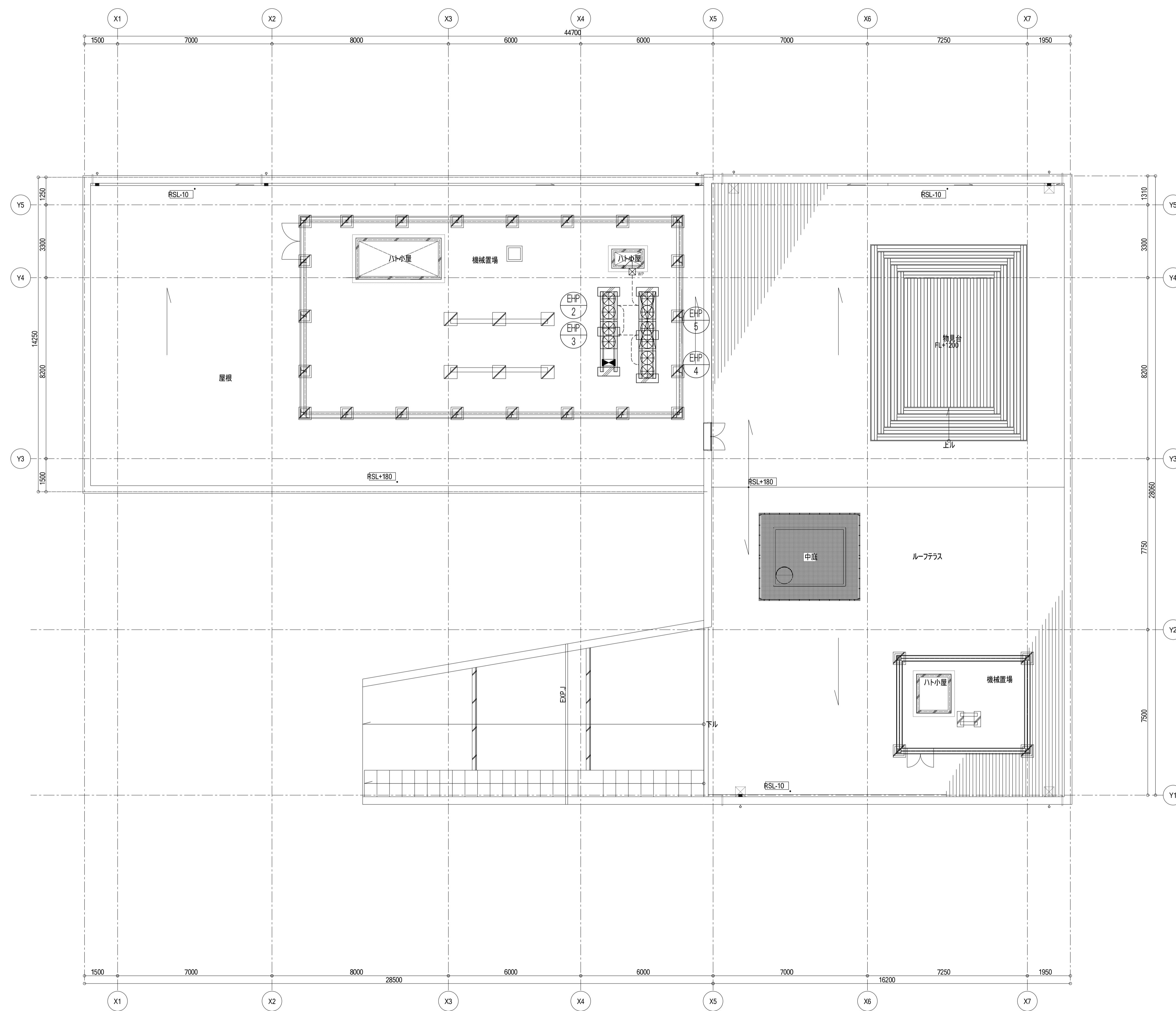
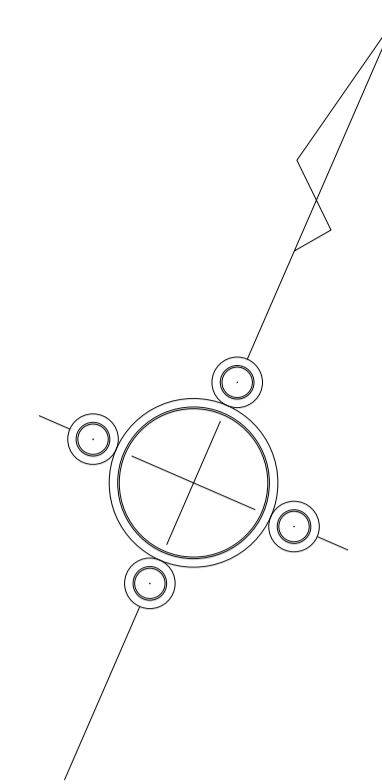

機器表

| 部屋名 | 仕様     | パネルヒーター(t=12) |          |          |          |          | コントローラ           | リレー                     | 電力量<br>(kW) |  |
|-----|--------|---------------|----------|----------|----------|----------|------------------|-------------------------|-------------|--|
|     |        | 1φ200V        |          |          |          |          | 塗装大四浅型2コ用<br>塗代付 | 塗装3コ用<br>スイッチボックス(カバー付) |             |  |
|     |        | MP-C236B(S)   | MP-C236B | MP-C216B | MP-C236N | MP-C233N | ME-821           | MR-92                   |             |  |
|     |        | 1888×909      | 1888×909 | 1888×303 | 1818×909 | 909×909  | 116W×120H×16.5D  | 160W×120H×7.6D          |             |  |
|     |        | 390 W         | 390 W    | 130 W    | 390 W    | 195 W    | 13.5A×2          | 16A×2回路                 |             |  |
| 1F  | 0歳児保育室 | 1             | 5        | 2        | 2        | 2        | 1                |                         | 3.770       |  |
|     | 1歳児保育室 | 1             | 7        |          | 5        | 3        | 1                | 1                       | 5.655       |  |
| 合計  |        | 2 枚           | 12 枚     | 2 枚      | 7 枚      | 5 枚      | 2 台              | 1 台                     | 9.425 kW    |  |

※コントローラにてウィークリータイマーが設定できる事。  
※消し忘れ防止機能有り。

施工区分

| 項目                             | 建築工事 | 床暖房工事 | 電気工事 |
|--------------------------------|------|-------|------|
| コントローラ裏BOX及び床下までの空配管           |      |       | ○    |
| 下地合板及び置き床工事                    | ○    |       |      |
| パネルヒーター敷設<br>(センサー付パネルヒーターを含む) |      | ○     |      |
| パネルヒーターとリードケーブルの接続             |      | ○     |      |
| 副材(合板)敷設                       | ○    |       |      |
| 床仕上工事                          | ○    |       |      |
| 一次側電源引込み(接地合)                  |      |       | ○    |
| コントローラ据付・結線                    |      | ○     |      |
| 試運転                            |      | ○     |      |

コントローラ姿図

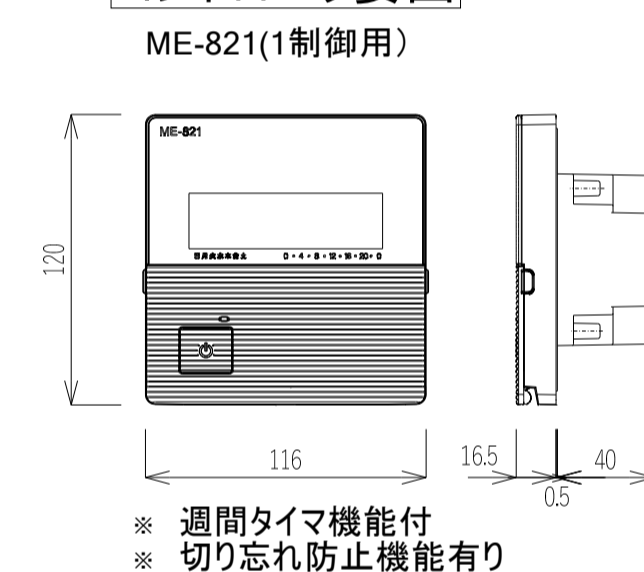

リレー姿図

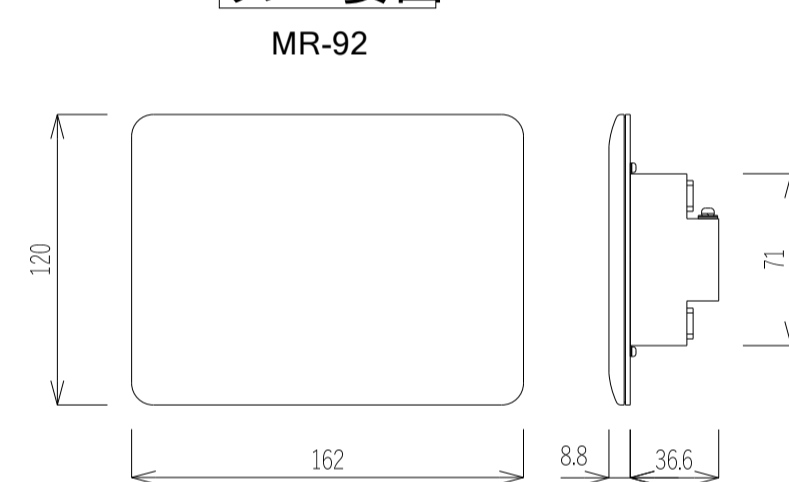

回路図

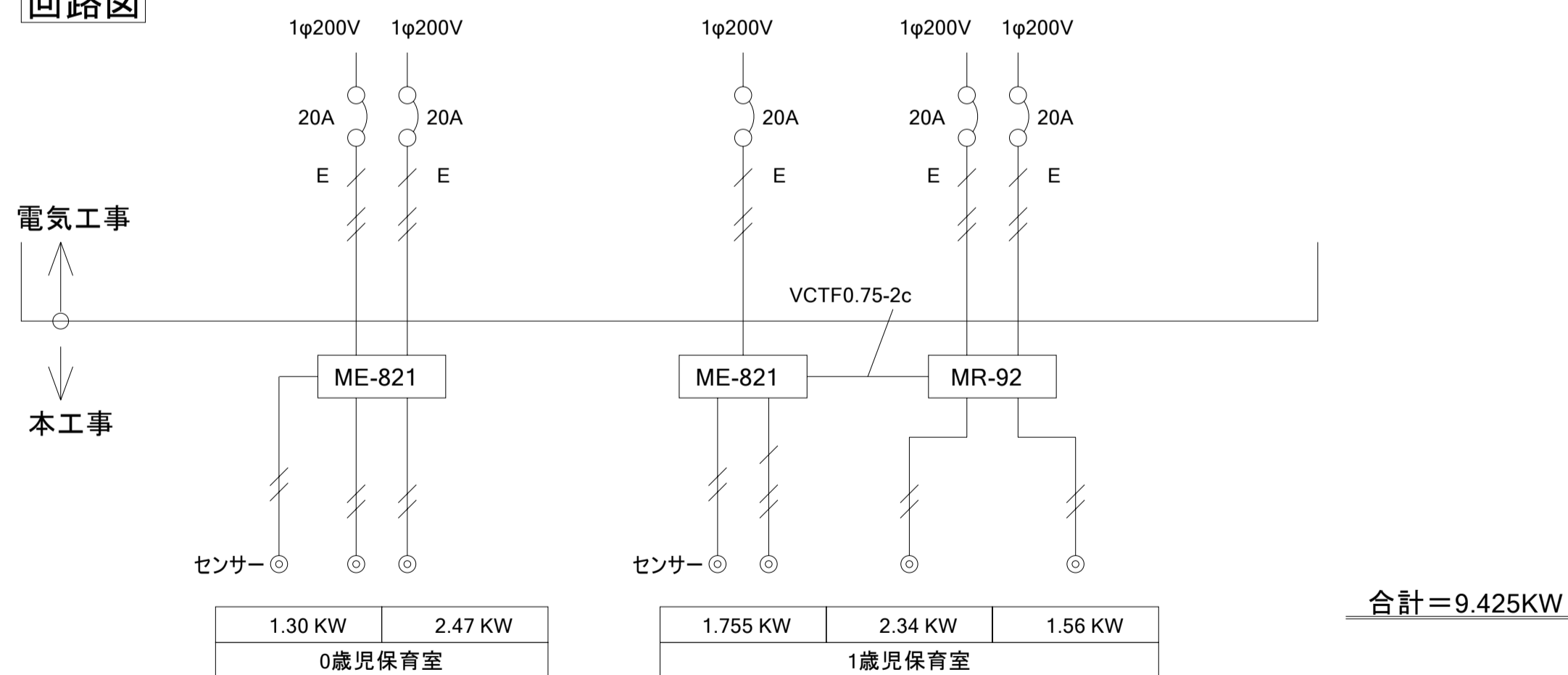

断面図  
(参考)

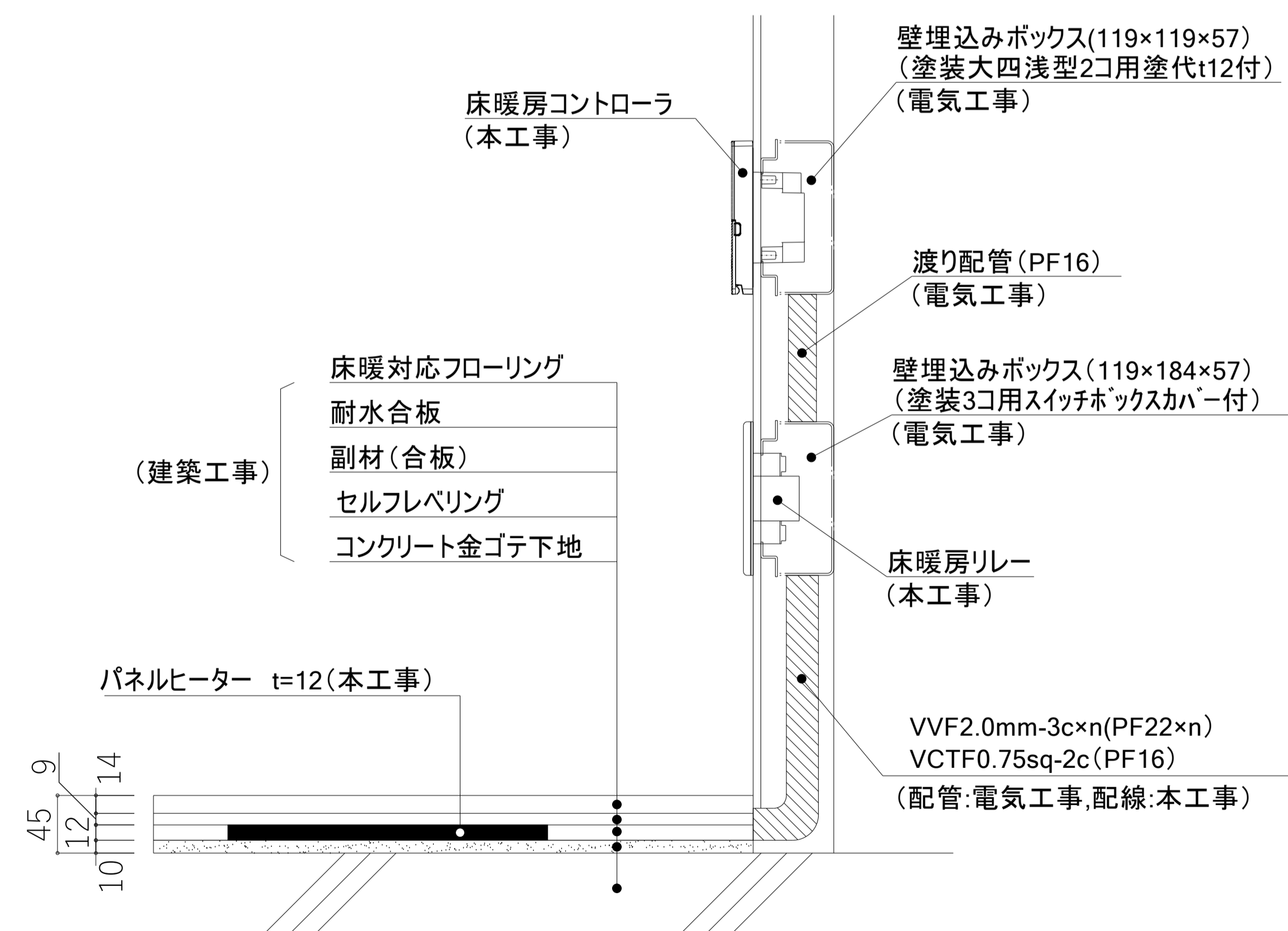





樹リスト(汚水)

| 記号 | 種類     | 地盤高<br>m | 管底高<br>GL<br>m | 樹深さ<br>(管底)<br>mm | 寸法<br>mm | 樹蓋            | 備考               |
|----|--------|----------|----------------|-------------------|----------|---------------|------------------|
| 1  | 小口径塩ビ樹 | 8.56     | 7.86           | 700               | 200φ     | 塩ビ蓋           | 化粧蓋付(建築工事)       |
| 2  | 小口径塩ビ樹 | 8.56     | 7.84           | 720               | 200φ     | 塩ビ蓋           | 化粧蓋付(建築工事)、トラップ付 |
| 3  | 小口径塩ビ樹 | 8.56     | 7.82           | 740               | 200φ     | 塩ビ蓋           | 化粧蓋付(建築工事)       |
| 4  | 小口径塩ビ樹 | 8.75     | 7.71           | 1,040             | 200φ     | 塩ビ蓋           | 化粧蓋付(建築工事)       |
| 5  | 小口径塩ビ樹 | 8.75     | 7.64           | 1,110             | 200φ     | 塩ビ蓋           | 化粧蓋付(建築工事)       |
| 6  | 小口径塩ビ樹 | 8.75     | 7.62           | 1,130             | 200φ     | 塩ビ蓋           | 化粧蓋付(建築工事)       |
| 7  | 小口径塩ビ樹 | 8.56     | 7.49           | 1,070             | 200φ     | 塩ビ蓋           | 化粧蓋付(建築工事)       |
| 8  | 小口径塩ビ樹 | 8.42     | 7.39           | 1,030             | 200φ     | 铸铁蓋(耐荷重:T-25) |                  |
| 9  | 小口径塩ビ樹 | 8.33     | 7.29           | 1,040             | 200φ     | 铸铁蓋(耐荷重:T-25) |                  |
| 10 | 小口径塩ビ樹 | 8.19     | 7.18           | 1,010             | 200φ     | 铸铁蓋(耐荷重:T-25) |                  |
| 11 | 小口径塩ビ樹 | 6.00     | 5.30           | 700               | 200φ     | 铸铁蓋(耐荷重:T-25) |                  |
| 12 | 小口径塩ビ樹 | 4.43     | 3.73           | 700               | 300φ     | 铸铁蓋(耐荷重:T-25) | 市章入り             |

樹リスト(雨水)

| 記号  | 種類      | 地盤高<br>m | 管底高<br>GL<br>m | 樹深さ<br>(管底)<br>mm | 寸法<br>mm | 樹蓋            | 備考         | 記号  | 種類     | 地盤高<br>m | 管底高<br>GL<br>m | 樹深さ<br>(管底)<br>mm | 寸法<br>mm | 樹蓋  | 備考         | 記号  | 種類     | 地盤高<br>m | 管底高<br>GL<br>m | 樹深さ<br>(管底)<br>mm | 寸法<br>mm | 樹蓋           | 備考 |  |
|-----|---------|----------|----------------|-------------------|----------|---------------|------------|-----|--------|----------|----------------|-------------------|----------|-----|------------|-----|--------|----------|----------------|-------------------|----------|--------------|----|--|
| A1  | 小口径塩ビ樹  | 8.53     | 7.83           | 700               | 200φ     | 塩ビ蓋           | 化粧蓋付(建築工事) | B1  | 集水樹    | 12.64    | 12.14          | 500               | 450□     | 集水蓋 |            | C1  | 小口径塩ビ樹 | 12.58    | 12.08          | 500               | 200φ     | 铸铁蓋(耐荷重:T-8) |    |  |
| A2  | 小口径塩ビ樹  | 8.65     | 7.78           | 870               | 200φ     | 塩ビ蓋           | 化粧蓋付(建築工事) | B2  | 集水樹    | 12.64    | 12.05          | 590               | 450□     | 集水蓋 |            | C2  | 小口径塩ビ樹 | 12.58    | 12.05          | 530               | 200φ     | 铸铁蓋(耐荷重:T-8) |    |  |
| A3  | 小口径塩ビ樹  | 8.65     | 7.67           | 980               | 200φ     | 塩ビ蓋           | 化粧蓋付(建築工事) | B3  | 集水樹    | 12.64    | 11.96          | 680               | 450□     | 集水蓋 |            | C3  | 小口径塩ビ樹 | 12.58    | 12.03          | 550               | 200φ     | 塩ビ蓋          |    |  |
| A4  | 小口径塩ビ樹  | 8.56     | 7.63           | 930               | 200φ     | 塩ビ蓋           | 化粧蓋付(建築工事) | B4  | 小口径塩ビ樹 | 12.64    | 11.89          | 750               | 200φ     | 塩ビ蓋 |            | C4  | 小口径塩ビ樹 | 12.58    | 11.78          | 800               | 200φ     | 塩ビ蓋          |    |  |
| A5  | 小口径塩ビ樹  | 8.56     | 7.61           | 950               | 200φ     | 塩ビ蓋           | 化粧蓋付(建築工事) | B5  | 集水樹    | 12.63    | 11.85          | 780               | 450□     | 集水蓋 |            | C5  | 小口径塩ビ樹 | 12.58    | 11.71          | 870               | 200φ     | 铸铁蓋(耐荷重:T-8) |    |  |
| A6  | 小口径塩ビ樹  | 8.34     | 7.48           | 860               | 200φ     | 铸铁蓋(耐荷重:T-25) |            | B6  | 小口径塩ビ樹 | 12.47    | 11.73          | 740               | 200φ     | 塩ビ蓋 |            | C6  | 小口径塩ビ樹 | 12.58    | 11.64          | 940               | 200φ     | 铸铁蓋(耐荷重:T-8) |    |  |
| A7  | 小口径塩ビ樹  | 8.34     | 7.28           | 1,060             | 200φ     | 铸铁蓋(耐荷重:T-25) |            | B7  | 小口径塩ビ樹 | 12.47    | 11.71          | 760               | 200φ     | 塩ビ蓋 |            | C7  | 小口径塩ビ樹 | 12.58    | 11.62          | 960               | 200φ     | 铸铁蓋(耐荷重:T-8) |    |  |
| A8  | コンクリート樹 | 8.23     | 6.84           | 1,390             | 900φ     | MHA           |            | B8  | 小口径塩ビ樹 | 12.47    | 11.69          | 780               | 200φ     | 塩ビ蓋 |            | C8  | 集水樹    | 12.52    | 11.52          | 1,000             | 450□     | 集水蓋          |    |  |
| A9  | 小口径塩ビ樹  | 5.9      | 5.10           | 800               | 200φ     | 铸铁蓋(耐荷重:T-25) |            | B9  | 小口径塩ビ樹 | 12.47    | 11.66          | 810               | 200φ     | 塩ビ蓋 |            | C9  | 小口径塩ビ樹 | 12.45    | 11.42          | 1,030             | 200φ     | 铸铁蓋(耐荷重:T-8) |    |  |
| A10 | 小口径塩ビ樹  | 4.5      | 3.70           | 800               | 300φ     | 铸铁蓋(耐荷重:T-25) | 市章マーク入り    | B10 | 集水樹    | 12.48    | 11.63          | 850               | 450□     | 集水蓋 |            | C10 | 集水樹    | 12.4     | 11.35          | 1,050             | 450□     | 集水蓋          |    |  |
| A11 | 集水樹     | 8.31     | 7.61           | 700               | 450□     | 集水蓋           |            | B11 | 小口径塩ビ樹 | 12.54    | 11.58          | 960               | 200φ     | 塩ビ蓋 |            | C11 | 小口径塩ビ樹 | 11.8     | 11.00          | 800               | 200φ     | 铸铁蓋(耐荷重:T-8) |    |  |
| A12 | 小口径塩ビ樹  | 8.33     | 7.53           | 800               | 200φ     | 铸铁蓋(耐荷重:T-25) |            | B12 | 小口径塩ビ樹 | 12.52    | 11.48          | 1,040             | 200φ     | 塩ビ蓋 |            | C12 | 小口径塩ビ樹 | 11.69    | 10.89          | 800               | 200φ     | 铸铁蓋(耐荷重:T-8) |    |  |
| A13 | 小口径塩ビ樹  | 8.33     | 7.42           | 910               | 200φ     | 铸铁蓋(耐荷重:T-25) |            | B13 | 小口径塩ビ樹 | 11.97    | 11.38          | 590               | 200φ     | 塩ビ蓋 |            | C13 | 小口径塩ビ樹 | 11.69    | 10.86          | 830               | 200φ     | 铸铁蓋(耐荷重:T-8) |    |  |
| A14 | 小口径塩ビ樹  | 8.17     | 7.34           | 830               | 200φ     | 铸铁蓋(耐荷重:T-25) |            | B14 | 小口径塩ビ樹 | 11.9     | 11.34          | 560               | 200φ     | 塩ビ蓋 |            | C14 | 小口径塩ビ樹 | 11.5     | 10.70          | 800               | 200φ     | 铸铁蓋(耐荷重:T-8) |    |  |
| A15 | 集水樹     | 8.15     | 7.45           | 700               | 450□     | 集水蓋           |            | B15 | 小口径塩ビ樹 | 11.82    | 11.26          | 560               | 200φ     | 塩ビ蓋 |            |     |        |          |                |                   |          |              |    |  |
| A16 | 小口径塩ビ樹  | 8.16     | 7.36           | 800               | 200φ     | 铸铁蓋(耐荷重:T-25) |            | B16 | 小口径塩ビ樹 | 11.77    | 11.18          | 590               | 200φ     | 塩ビ蓋 |            |     |        |          |                |                   |          |              |    |  |
| A17 | 集水樹     | 7.96     | 7.16           | 800               | 450□     | 集水蓋           |            | B17 | 集水樹    | 11.75    | 11.16          | 590               | 450□     | 集水蓋 |            |     |        |          |                |                   |          |              |    |  |
| A18 | 集水樹     | 7.96     | 7.06           | 900               | 450□     | 集水蓋           |            | B18 | 集水樹    | 11.72    | 11.09          | 630               | 450□     | 集水蓋 |            |     |        |          |                |                   |          |              |    |  |
| A19 | 小口径塩ビ樹  | 8.1      | 6.97           | 1,130             | 200φ     | 铸铁蓋(耐荷重:T-25) |            | B19 | 集水樹    | 11.69    | 11.00          | 690               | 450□     | 集水蓋 |            |     |        |          |                |                   |          |              |    |  |
| A20 | コンクリート樹 | 8.36     | 6.88           | 1,480             | 900φ     | MHA           |            | B20 | 小口径塩ビ樹 | 11.69    | 10.99          | 700               | 200φ     | 塩ビ蓋 | 化粧蓋付(建築工事) |     |        |          |                |                   |          |              |    |  |
|     |         |          |                |                   |          |               |            | B21 | 集水樹    | 12.5     | 12.00          | 500               | 450□     | 集水蓋 |            |     |        |          |                |                   |          |              |    |  |
|     |         |          |                |                   |          |               |            | B22 | 集水樹    | 12.47    | 11.97          | 500               | 450□     | 集水蓋 |            |     |        |          |                |                   |          |              |    |  |
|     |         |          |                |                   |          |               |            | B23 | 集水樹    | 11.85    | 11.35          | 500               | 450□     | 集水蓋 |            |     |        |          |                |                   |          |              |    |  |

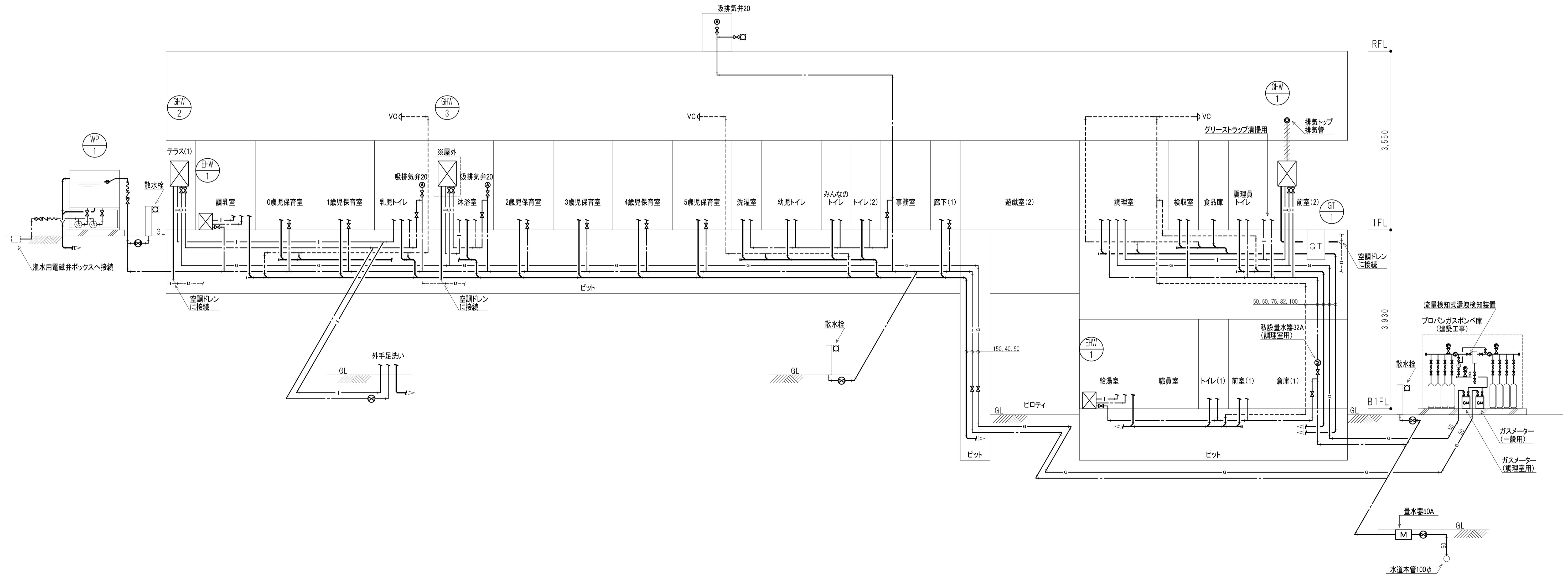

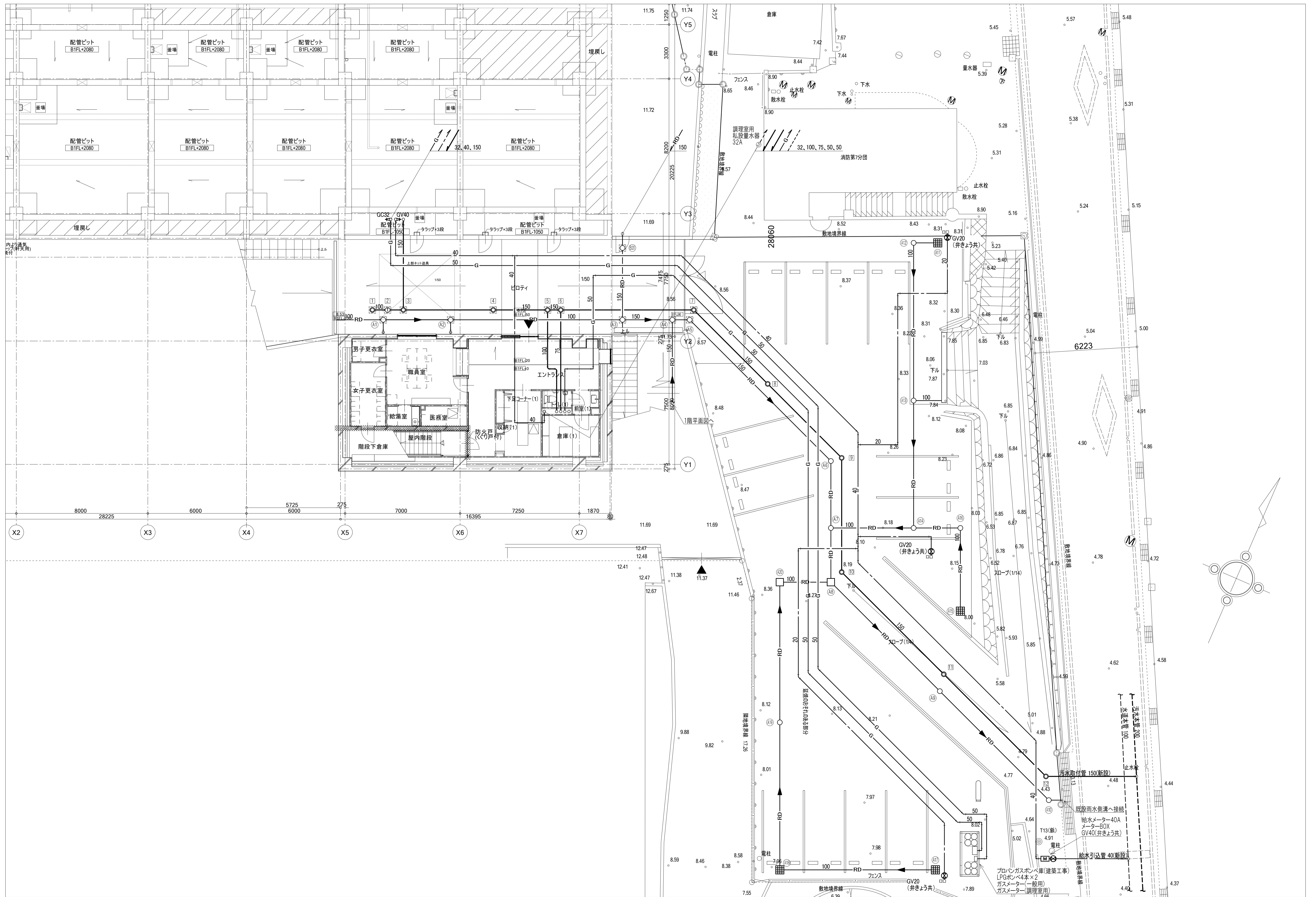



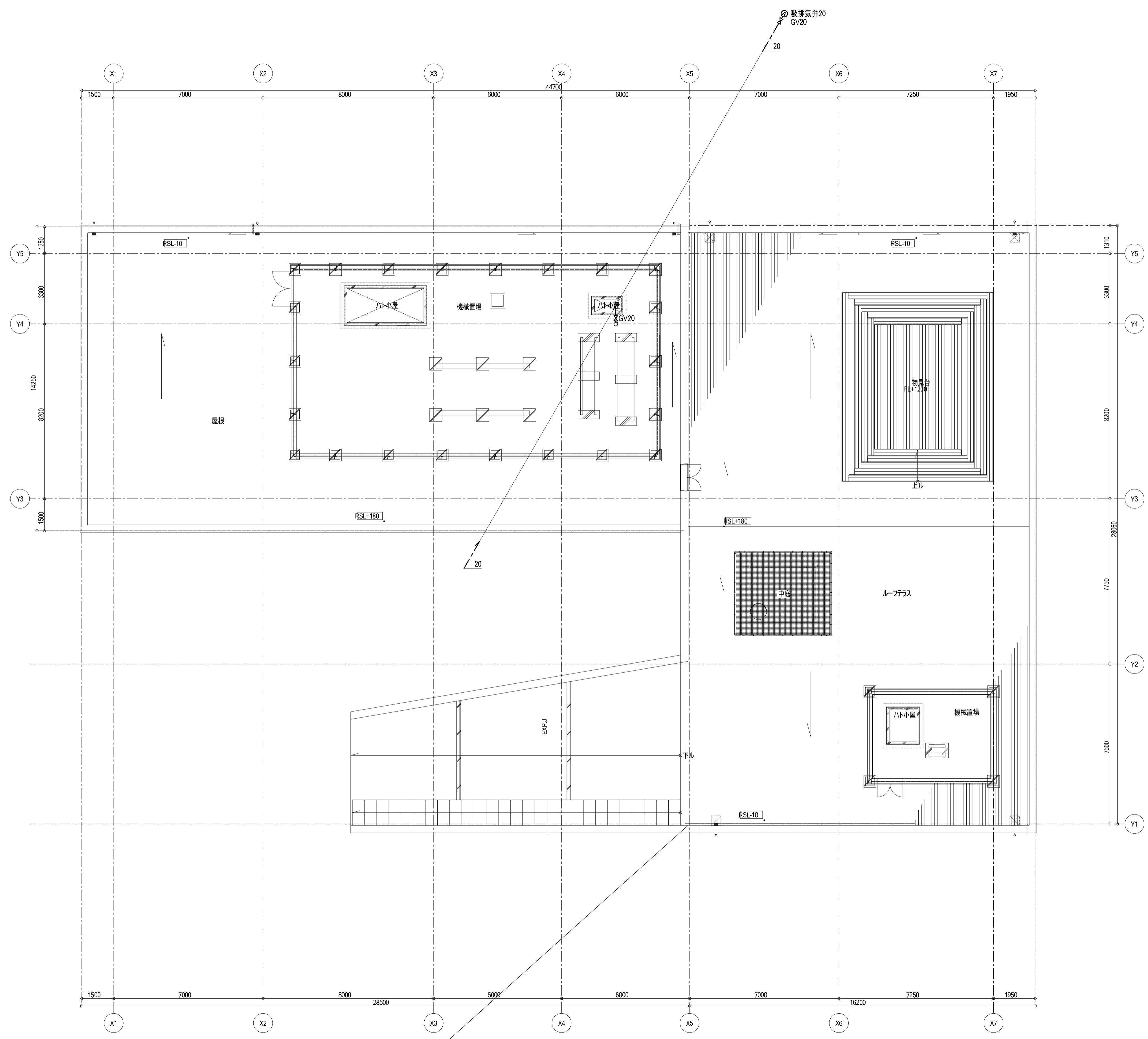

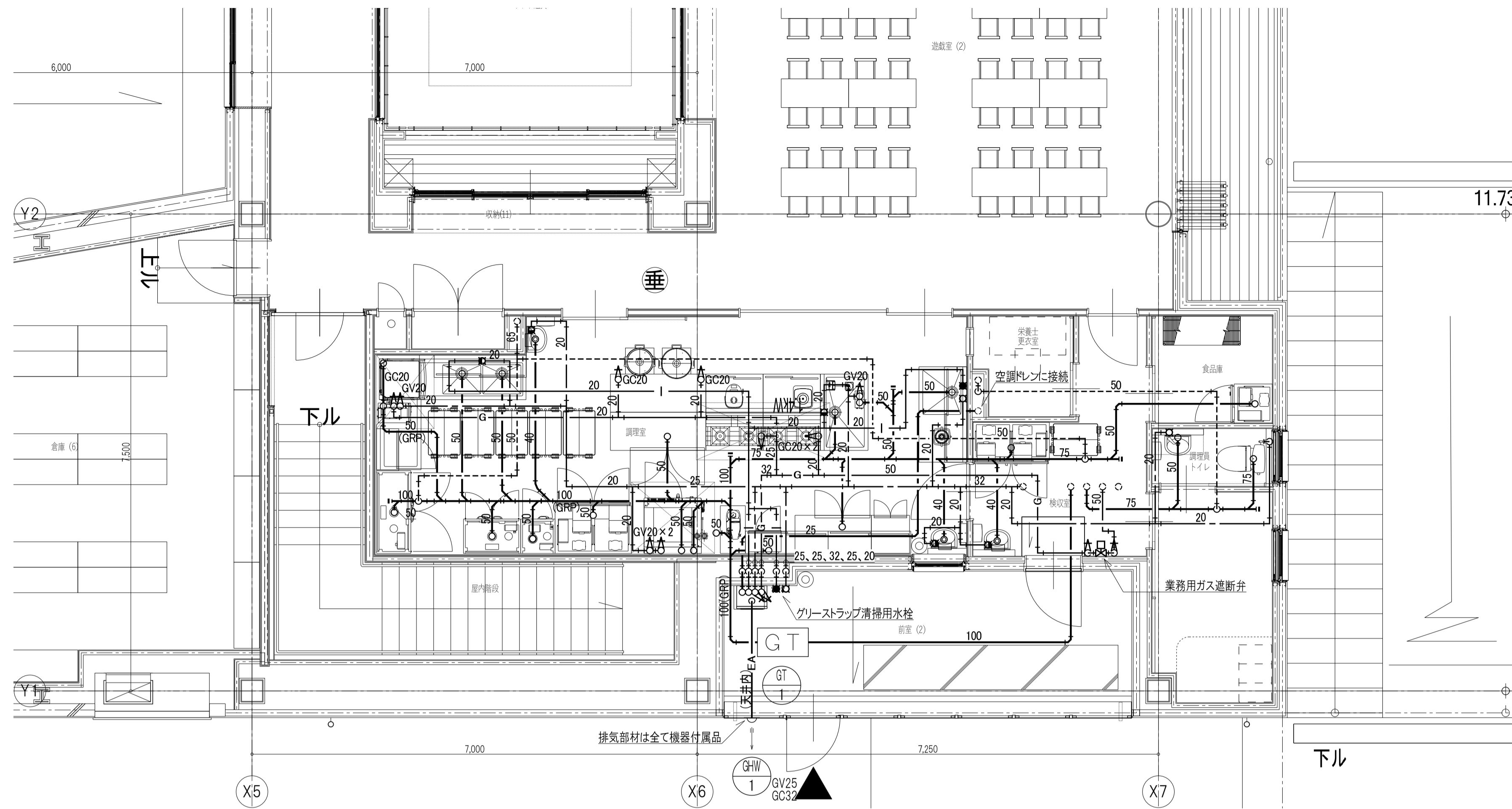

1階詳細図(1)

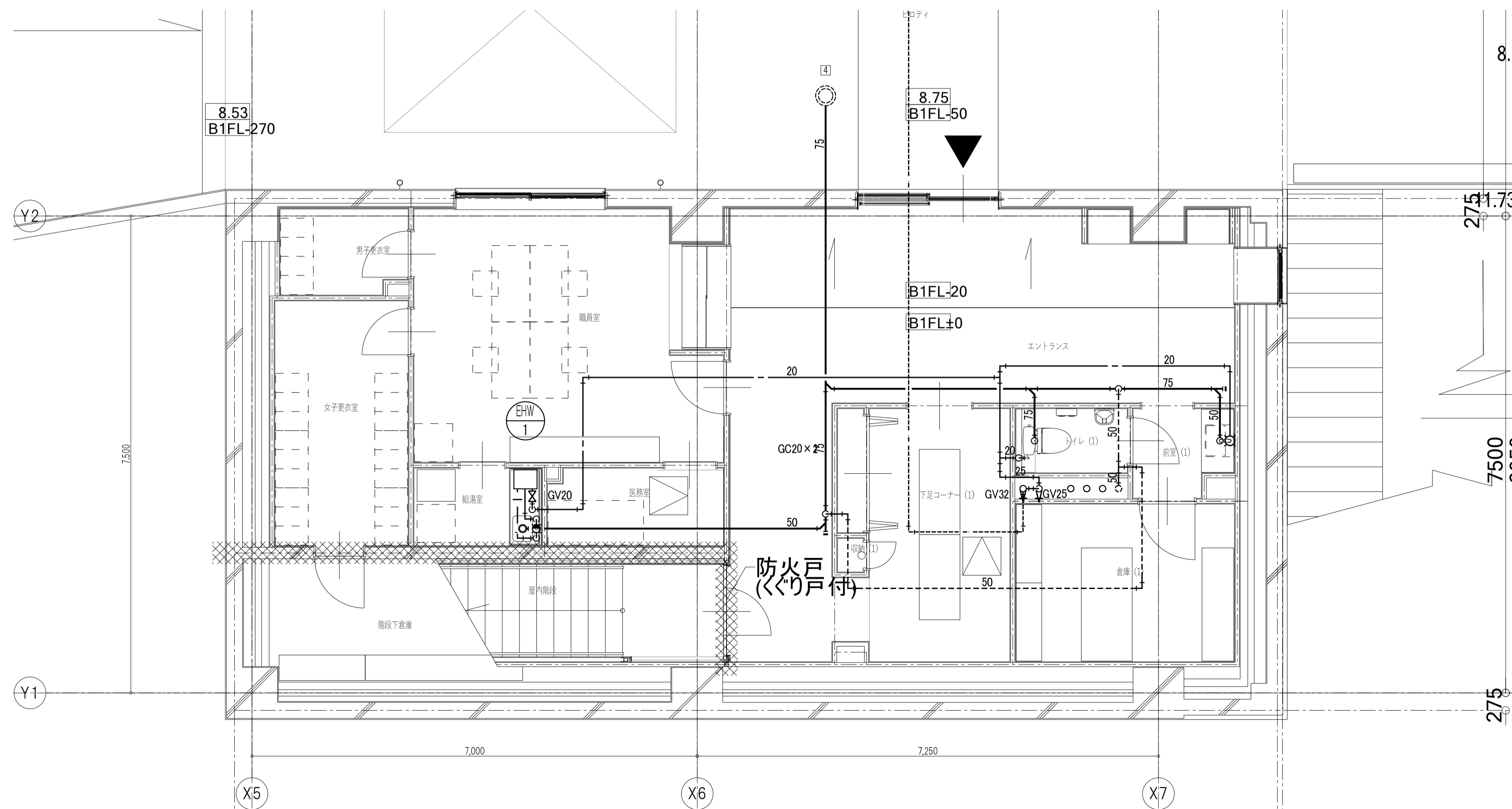

地下1階詳細図

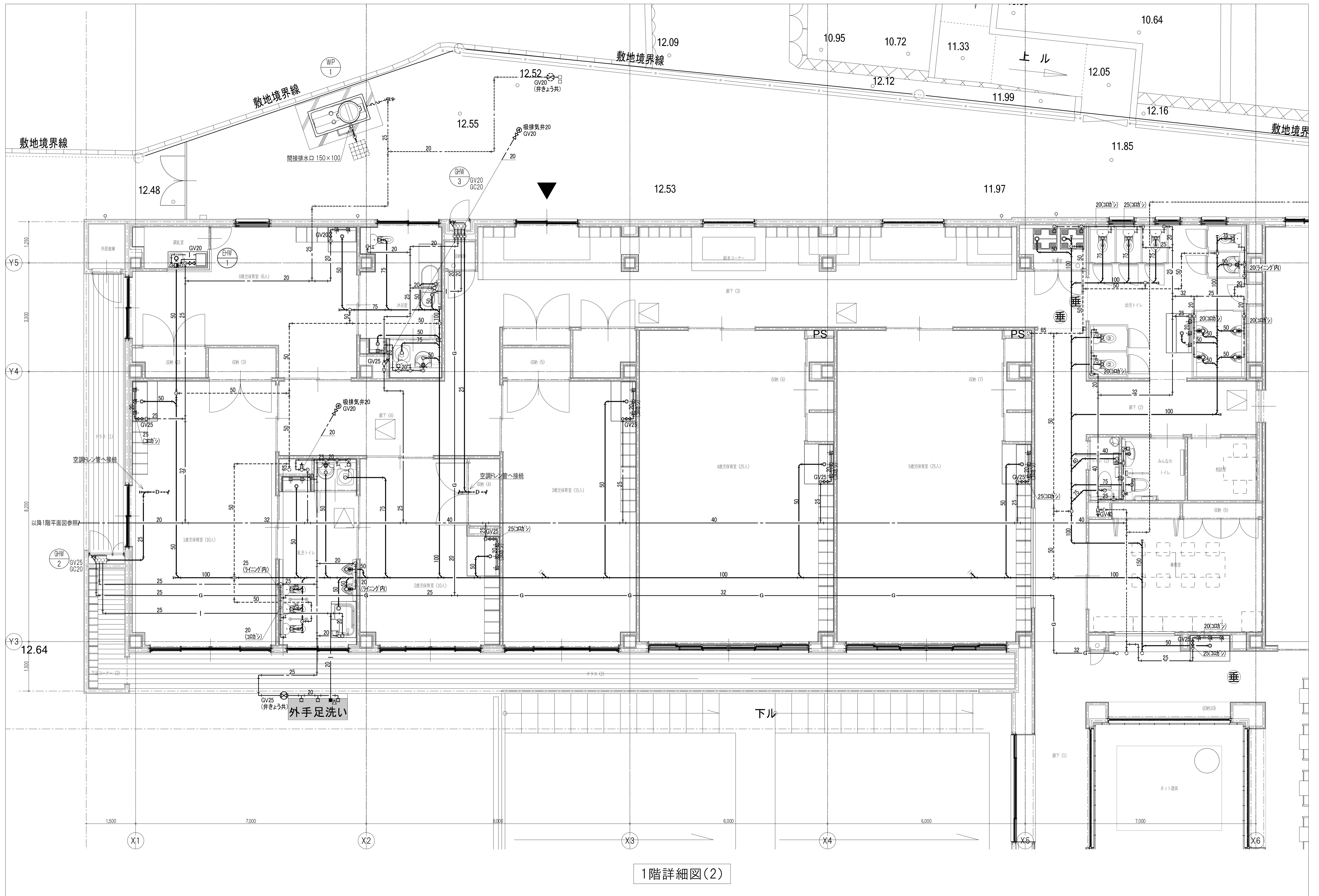

1階詳細図(2)